



Legend for fold-out page

Pos.	Description	Detailed information
	Function module E82ZAFSC / E82ZAFSC001	
A	Switch for the configuration of the analog input (terminal X3/8)	 41
B	Digital and analog inputs and outputs, terminal strip X3	 39
C	Nameplate	 32

1	About this documentation	26
	Conventions used	27
	Notes used	28
2	Safety instructions	29
3	Product description	30
	Function	30
	Application as directed	30
	Scope of supply	31
	Identification	32
4	Technical data	33
	Connection data	33
	Operating conditions	33
	Dimensions	34
5	Mechanical installation	35
6	Electrical installation	36
	Wiring according to EMC	36
	Wiring	37
7	Commissioning	40
	Before switching on	40
	DIP switch position	41
	Commissioning steps	42

1 About this documentation

Contents

This documentation includes ...

- ▶ Information about the mechanical and electrical installation of the function module;
- ▶ Information about the commissioning of the function module;
- ▶ Safety instructions which you must observe in any case;
- ▶ Data about the versions of Lenze basic devices to be used;
- ▶ Technical data.

Validity information

The information given in this documentation is valid for the following devices:

Function module	Type designation	As of hardware version
STANDARD I/O	E82ZAFSC	3A
STANDARD I/O (coated)	E82ZAFSC001	3A

Target group

This documentation is directed at persons who install and commission the described product according to the project requirements.





Tip!

Documentation and software updates for further Lenze products can be found on the Internet in the "Services & Downloads" area under

<http://www.Lenze.com>

Conventions used

This documentation uses the following conventions to distinguish between different types of information:

Type of information	Identification	Examples/notes
Numbers		
Decimal separator	Point	The decimal point is used throughout this documentation. Example: 1234.56
Symbols		
Page reference		Reference to another page with additional information Example:  16 = see page 16

1 About this documentation

Notes used

Notes used

The following pictographs and signal words are used in this documentation to indicate dangers and important information:

Safety instructions

Structure of safety instructions:





Danger!



(characterises the type and severity of danger)

Note

(describes the danger and gives information about how to prevent dangerous situations)

Pictograph and signal word	Meaning
 Danger!	Danger of personal injury through dangerous electrical voltage. Reference to an imminent danger that may result in death or serious personal injury if the corresponding measures are not taken.
 Danger!	Danger of personal injury through a general source of danger. Reference to an imminent danger that may result in death or serious personal injury if the corresponding measures are not taken.
 Stop!	Danger of property damage. Reference to a possible danger that may result in property damage if the corresponding measures are not taken.

Application notes

Pictograph and signal word	Meaning
 Note!	Important note to ensure troublefree operation
 Tip!	Useful tip for simple handling
	Reference to another documentation

**Danger!**

Inappropriate handling of the function module and the basic device can cause serious injuries to persons and damage to material assets.

Observe the safety instructions and residual hazards included in the documentation of the basic device.

**Stop!****Electrostatic discharge**

Electronic components within the function module can be damaged or destroyed by electrostatic discharge.

Possible consequences:

- ▶ The function module is defective.

Protective measures

- ▶ Free yourself from any electrostatic charge before you touch the module.

3 Product description

Function

Function

The function module allows the control of Lenze frequency inverters and the Lenze Drive PLC with analog and digital control signals.

Application as directed

The function module ...

- ▶ is an accessories unit which can be used with the following Lenze basic devices:

Function module	Lenze basic devices		
	Product range	Product name	As of hardware version
E82ZAFSC	Frequency inverter	8200 vector	Vx14
	Drive PLC	Drive PLC	1x20
E82ZAFSC001	Frequency inverter	8200 motec	Vx14

- ▶ is an equipment to be used in industrial power systems.
- ▶ allows for the control of Lenze frequency inverters and the Lenze Drive PLC with analog and digital control signals.

Any other use shall be deemed inappropriate!

Scope of supply

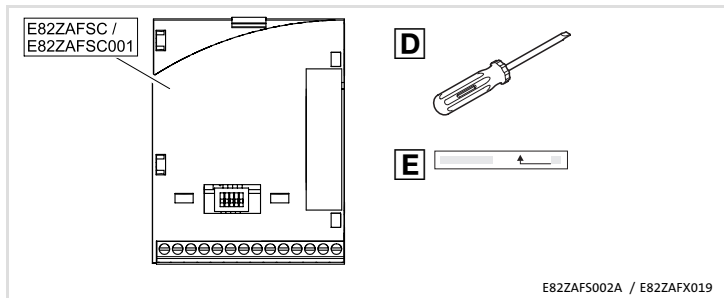

Pos.	Scope of supply
	Function module E82ZAFSC / E82ZAFSC001
D	Screw driver
E	Sticker
	Mounting Instructions

3 Product description

Identification

Identification

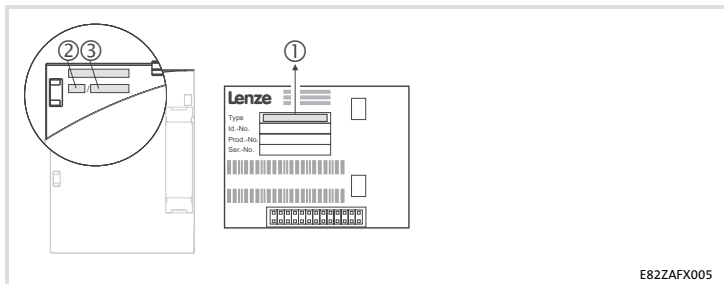

	①	②	③
Product range	E82ZAF	s	c
STANDARD I/O			
Generation			
Variant			
000: standard			
001: coated PCBs			
Hardware version			

Connection data

X3/	Values	
62	Resolution: 10 bit Linearity distortion: $\pm 0.5\%$ Temperature distortion: 0.3 % (0 ... +60 °C) Carrying capacity $I_{\max} = 2\text{ mA}$	
8	Resolution: 10 bit Linearity distortion: $\pm 0.5\%$ Temperature distortion: 0.3 % (0 ... +60 °C) Input resistance <ul style="list-style-type: none"> • $R_{\text{Input}} > 50\text{ k}\Omega$ (with voltage signal) • $R_{\text{Input}} = 250\ \Omega$ (with current signal) 	
9	Carrying capacity $I_{\max} = 10\text{ mA}$	
7	isolated from terminal X3/39 (GND2)	
20	Load capacity: $\Sigma I_{\max} = 40\text{ mA}$	
28	Input resistance: 3.3 k Ω	
E1 ¹⁾		
E2 ¹⁾		1 = HIGH (+12 ... +30 V), PLC level, HTL
E3		0 = LOW (0 ... +3 V), PLC level, HTL
E4		
39	isolated from terminal X3/7 (GND1)	
A1	Load capacity: $I_{\max} = 10\text{ mA}$, with internal supply $I_{\max} = 50\text{ mA}$, with external supply	

1) Frequency input alternatively 0 ... 10 kHz single-track or 0 ... 1 kHz two-track, config. via C0425

Operating conditions

Ambient conditions

Climate

Storage	IEC/EN 60721-3-1	1K3 (-25 to +60 °C)
Transport	IEC/EN 60721-3-2	2K3 (-25 to +70 °C)
Operation	Corresponding to the data of the Lenze basic device used (see documentation of the basic device).	
Pollution	EN 61800-5-1	Degree of pollution 2

4 Technical data

Dimensions

Dimensions

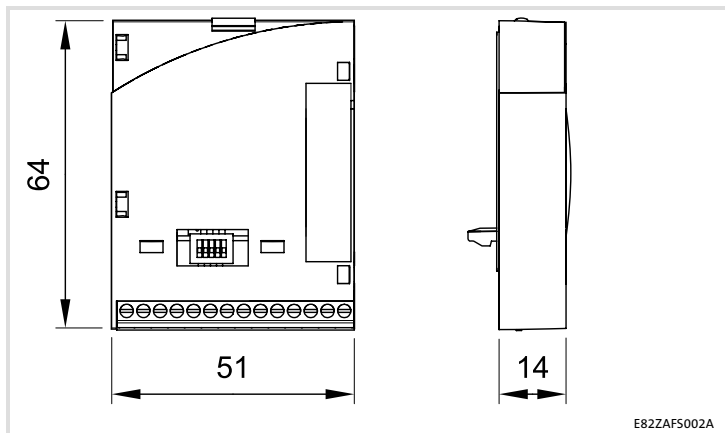

E82ZAFS002A

All dimensions in mm

Follow the notes given in the Mounting Instructions for the standard device for the mechanical installation of the function module.

The Mounting Instructions for the standard device ...

- ▶ are part of the scope of supply and are enclosed with each device.
- ▶ provide tips for avoiding damage through improper handling.
- ▶ describe the obligatory order of installation steps.

6 Electrical installation

Wiring according to EMC

Wiring according to EMC

Please observe the following for wiring according to EMC guidelines:







Note!

- ▶ Separate control cables from motor cables.
- ▶ Lead the shields as far as possible to the terminals (unshielded core length < 40 mm).
- ▶ Connect control and data cable shields as follows:
 - *Analog* signal cable shields must be connected *with one end* at the inverter.
 - *Digital* signal cable shields must be connected *with both ends*.
- ▶ More information about wiring according to EMC guidelines can be obtained from the corresponding documentation for the standard device.

Wiring

Terminal data

Range	Values	
Electrical connection	Terminal strip with screw connection	
Possible connections	rigid:	
		1.5 mm ² (AWG 16)
	flexible:	
		without wire end ferrule 1.0 mm ² (AWG 18)
		with wire end ferrule, without plastic sleeve 0.5 mm ² (AWG 20)
	with wire end ferrule, with plastic sleeve 0.5 mm ² (AWG 20)	
Tightening torque	0.22 ... 0.25 Nm (1.9 ... 2.2 lb-in)	
Bare end	5 mm	

6 Electrical installation

Wiring

Supply via the internal voltage source (X3/20):

- ▶ X3/28, controller inhibit (CINH)
- ▶ X3/E1 ... X3/E4, digital inputs

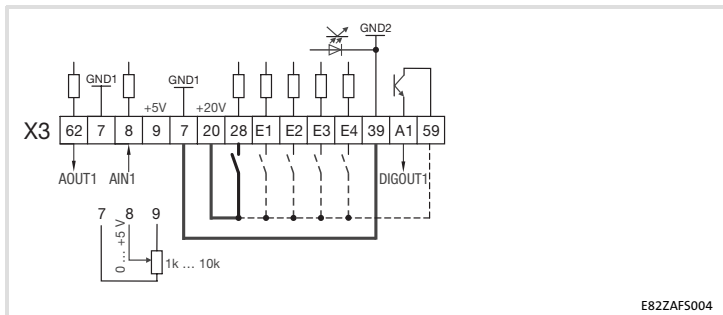

E82ZAFS004

Supply via an external voltage source:

- ▶ X3/28, controller inhibit (CINH)
- ▶ X3/E1 ... X3/E4, digital inputs

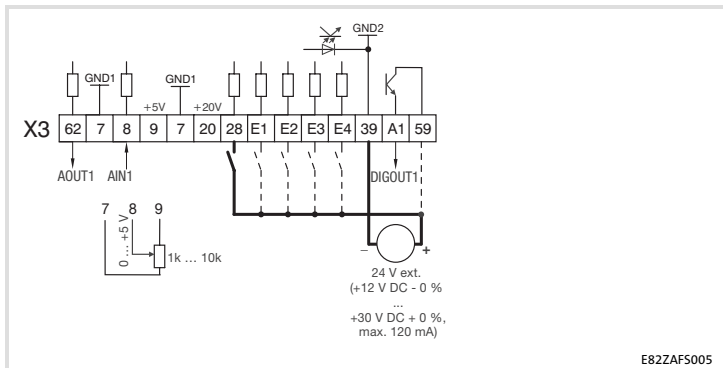

E82ZAFS005

— The min. wiring requirements for operation

X3/ Signal type	Function (Lenze setting: bold print)	Level (Lenze setting: bold print)		
62	Analog output Output frequency	0 ... +6 V 0 ... +10 V ¹⁾		
7	-	GND1, Reference potential for analog signals -		
8	Analog input Input for actual value or setpoint Switch over the range with the DIP switch and in C0034: <ul style="list-style-type: none"> Voltage signal Current signal 	0 ... +5 V 0 ... +10 V -10 ... +10 V ²⁾ 0 ... +20 mA +4 ... +20 mA +4 ... +20 mA (open-circuit monitored)		
9	-	Internal, stabilised DC voltage source for the setpoint potentiometer +5.2 V		
20	-	Internal DC voltage supply for control of digital inputs and outputs +20 V ±10 % (ref.: X3/7)		
28	Controller inhibit (CINH)	1 = enable		
E1 ³⁾	Digital inputs Activation of JOG frequencies JOG1 = 20 Hz JOG2 = 30 Hz JOG3 = 40 Hz		e1	E2
E2 ³⁾		JOG1	1	0
		JOG2	0	1
E3	Digital inputs DC-injection brake (DCB) Change of direction of rotation CW/CCW rotation		1 = DCB	
E4			E4	
		CW	0	
		CCW	1	
39	-	GND2, Reference potential for digital signals -		
A1	Digital output Ready for operation <ul style="list-style-type: none"> internal supply: external supply: 	0 ... +20 V 0 ... +24 V		
59	-	DC supply for X3/A1 <ul style="list-style-type: none"> internal (bridge to X3/20): external: 	+20 V +24 V	

1) Output level 0 ... +10 V: Adapt offset (C0109/C0422) and gain (C0108/C0420)

2) Adjust offset (C0026) and gain (C0027) separately for each function module ...
- after replacing the function module or the basic device.
- after loading the Lenze setting.

3) Frequency input alternatively 0 ... 10 kHz single-track or 0 ... 1 kHz two-track, config. via C0425

7 Commissioning

Before switching on

Before switching on



Note!

- ▶ If you carry out the commissioning with a configuration different from the Lenze setting, read the instructions on "Individual Settings" (📖 42).
- ▶ Make sure
 - that you have correctly set the setpoint range with the DIP switch on the function module (📖 41).
 - that C0034 is adjusted to the settings of the DIP switch (📖 41).
Example: setpoint selection (0 V ... +5 V) via potentiometer at X3/7, X3/8 and X3/9
⇒ C0034 = 0, DIP switch 1, 2, 4 and 5 = OFF, 3 = ON

DIP switch position



Note!

- ▶ Make sure to set the DIP switch and C0034 to the same range, otherwise the analog input signal at X3/8 will be interpreted incorrectly by the basic device.
- ▶ If a setpoint potentiometer is supplied internally via X3/9, make sure to set the DIP switch to the voltage range 0 ... 5 V. Otherwise it will be impossible to cover the entire speed range.

Signal at X3/8	Switch position					C0034
	1	2	3	4	5	
0 ... 5V	OFF	OFF	ON	OFF	OFF	0
0 ... 10 V (Lenze setting)	OFF	OFF	ON	OFF	ON	0
0 ... 20 mA	OFF	OFF	ON	ON	OFF	0
4 ... 20 mA	OFF	OFF	ON	ON	OFF	1
4 ... 20 mA (open-circuit monitored)	OFF	OFF	ON	ON	OFF	3
-10 ... +10 V	ON	ON	OFF	OFF	OFF	2

7 Commissioning

Commissioning steps

Commissioning steps

Step	Procedure	Description
1.	Switch on the mains voltage.	The basic device will be ready for operation after approx. 1 second. The controller inhibit is active. Drive response: The green LED is blinking. Keypad: RDY IMP (if attached)
2.	Control digital inputs.	Lenze setting: <ul style="list-style-type: none">• CW rotation:<ul style="list-style-type: none">– E1, E2, E3, E4: LOW• CCW rotation:<ul style="list-style-type: none">– E1, E2, E3: LOW– E4: HIGH Individual setting: <ul style="list-style-type: none">• Adapt digital inputs under C0007 or C0410.• The digital inputs must be controlled so that the drive can start via terminal after controller enable.
3.	Provide a setpoint	Lenze setting: Setpoint: 0 ... +10 V Individual setting: <ul style="list-style-type: none">• Depending on the position of the DIP switch at the function module<ul style="list-style-type: none">– apply master current to X3/8 <u>or</u>– Apply master voltage at X3/8.• Check C0034.
4.	Release the controller via the terminal.	Lenze setting: X3/28 = HIGH (+12 ... +30 V) Drive response: <ul style="list-style-type: none">• The green LED is on.• Keypad: IMP goes off.
5.	The drive should be running now.	



Note!

The basic device is only functioning if a HIGH level is applied to X3/28 (controller release via terminal).

- ▶ Please observe that the controller can be inhibited through various sources. All sources act like a series connection of switches.
- ▶ If the drive does not start in spite of the controller release via X3/28, check if the controller inhibit is set via another source. Another source could be the **STOP** key of the keypad.