

SIEMENS

SIMOVERT MASTERDRIVES

Guidelines for changing over from the
CU2 control module to CUVC

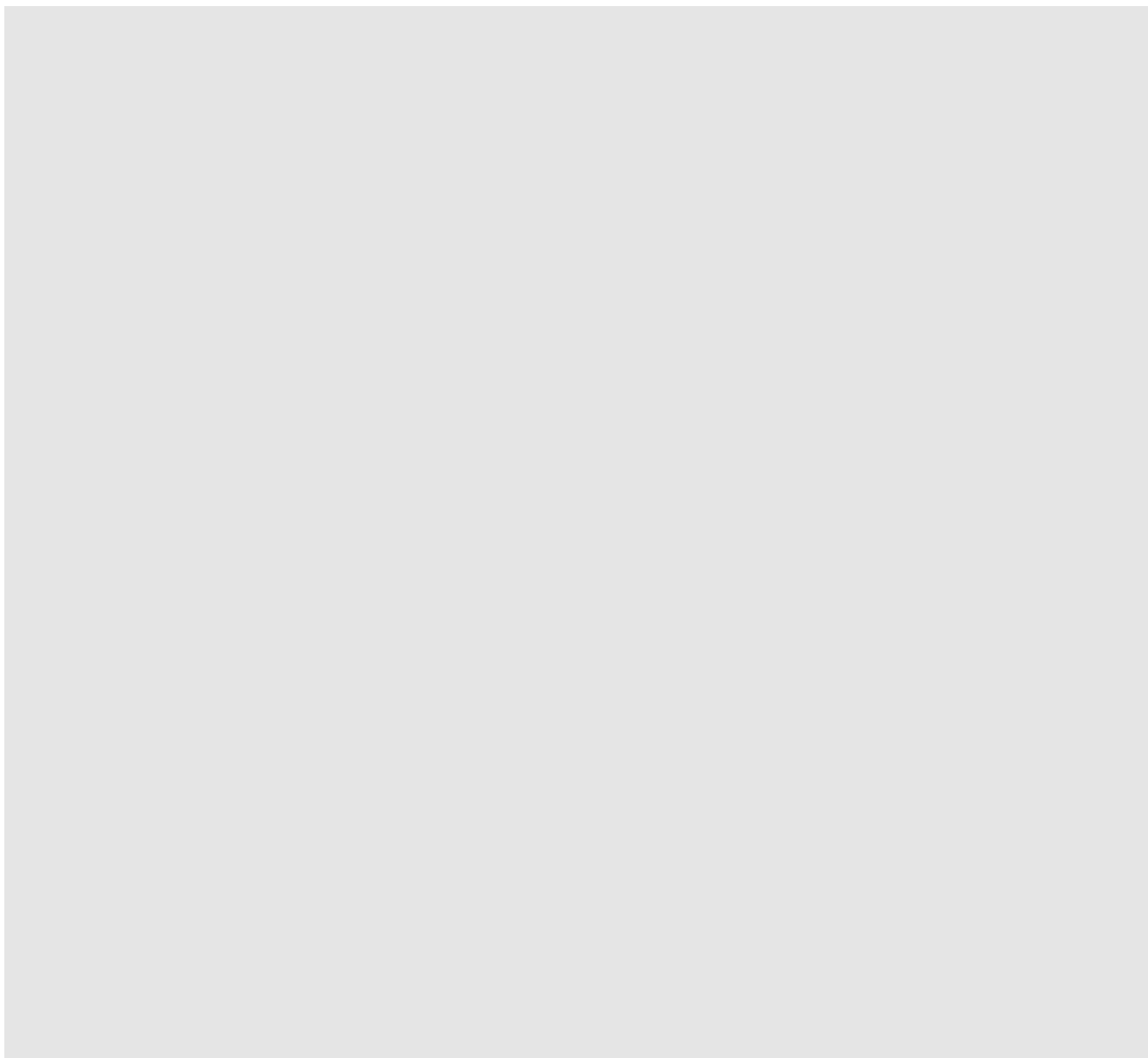

We reserve the right to make changes to functions, technical data, standards, drawings and parameters.

The reproduction, transmission or use of this document or its contents is not permitted without express written authority. Offenders will be liable for damages. All rights, including rights created by patent grant or registration of a utility model or design, are reserved.

We have checked the contents of this document to ensure that they coincide with the described hardware and software. However, differences cannot be completely excluded, so that we do not accept any guarantee for complete conformance. However, the information in this document is regularly checked and necessary corrections will be included in subsequent editions. We are grateful for any recommendations for improvement.

SIMOVERT® Registered Trade Mark

Contents

1	Hardware CUVC	1-1
1.1	Control connections.....	1-1
1.2	Comparison of the terminals CU2 ⇒ CUVC.....	1-6
2	EB2 – Expansion Board	2-1
2.1	Definitions and Warnings.....	2-1
2.2	Description.....	2-3
2.3	Technical Data.....	2-4
2.4	Installation	2-5
2.5	Connecting-up	2-6
2.6	Start-up.....	2-8
3	Function blocks and parameters	3-1
3.1	Function blocks.....	3-1
3.2	Connectors and binectors.....	3-2
3.3	Parameters	3-4
3.4	Connecting up function blocks (BICO system)	3-8
4	Start-up	4-1
4.1	Parameter reset to factory setting	4-1
4.2	Detailed parameterization.....	4-2
4.2.1	Power section definition.....	4-3
4.2.2	Board configuration	4-3
4.2.3	Drive setting.....	4-4
4.2.4	Start-up functions	4-11
4.3	Change to the parameter function selection (P052) VCalt	4-12

5	Process data	5-1
5.1	Control word 1 (visualization parameter r550 or r967)	5-1
5.2	Control word 2 (visualization parameter r551).....	5-2
5.3	Description of the control word bits	5-4
5.4	Status word 1 (visualization parameter r552 or r968).....	5-12
5.5	Status word 2 (visualization parameter r553)	5-13
5.6	Possible targets for the wiring of the binectors of the status words.....	5-15
5.7	Description of the status word bits.....	5-17
5.8	Setpoint wiring.....	5-23
5.8.1	Important setpoints	5-23
5.8.2	Important setpoint sources	5-23
5.8.2.1	Interfaces.....	5-23
5.8.2.2	Analog inputs AI	5-24
5.8.2.3	Fixed setpoints FSW	5-24
5.9	Actual value wiring.....	5-25
5.9.1	Analog outputs AO	5-25
5.9.2	Interfaces.....	5-25
5.9.3	General.....	5-26
5.9.4	Other drive converter parameters.....	5-26
5.9.5	Setpoint channel speed/frequency	5-27
5.9.6	Setpoint channel torque/current	5-27
5.9.7	Actual values speed/frequency.....	5-28
5.9.8	Closed-loop control.....	5-28
6	Drive converter functions (WEA, KIP, FLN...).....	6-1
6.1	Automatic restart (WEA).....	6-1
6.2	Kinetic buffering (KIP) / flexible response (FLN)	6-1
6.3	Closed-loop Udmax control	6-1
6.4	DC current braking (DC brake).....	6-2
6.5	Restart-on-the-fly.....	6-2
6.6	Synchronization (Sync.).....	6-2
6.7	Technology controller	6-3
6.8	Open-loop brake control.....	6-3

7	Function Diagrams	7-1
8	Lists (BDS, FDS, MDS, Binector, Connector)	8-1
9	Parameter List	9-1
10	Cross-Reference-Lists	10-1
10.1	Converting CU2 parameters to CUVC parameters	10-1
10.2	Converting CUVC parameters to CU2 parameters	10-17
10.3	Converting CUVC binectors to CU2 parameters.....	10-29
10.4	Converting CUVC connectors to CU2 parameters.....	10-32
11	Faults and Alarms	11-1
12	Guidelines to changeover from CB1 to CBP	12-1
12.1	Reasons for the changeover	12-1
12.2	Comparison, CB1 ↔ CBP	12-3
12.3	Parameter numbers of the individual CUs regarding PROFIBUS	12-4
12.4	Information on the GSD- and type files for the new COM-BOARD CBP.....	12-5
12.5	Examples of the steps required.....	12-8
12.5.1	General information	12-8
12.5.2	Configuring steps in the DP master "SIMATIC S5"	12-8
12.5.3	Configuring steps in the DP master "SIMATIC S7"	12-11

1 Hardware CUVC

1.1 Control connections

Standard connections

In the basic version, the unit has the following control connections on the CUVC:

- ◆ Serial interface (RS232 / RS485) for PC or OP1S
- ◆ A serial interface (USS bus, RS485)
- ◆ A control terminal strip for connecting up a HTL unipolar pulse encoder and a motor temperature sensor (PTC / KTY84)
- ◆ Two control terminal strips with digital and analog inputs and outputs.

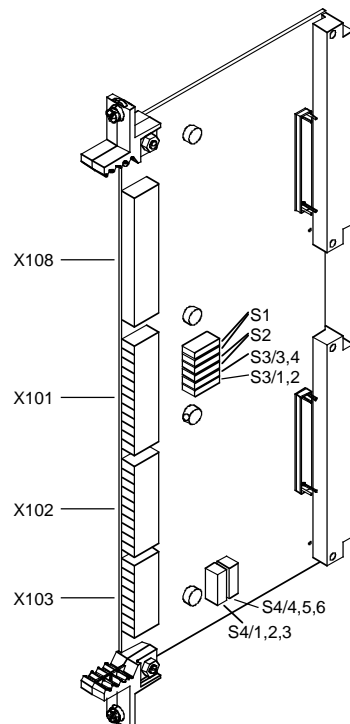

Fig. 1-1 View of the CUVC

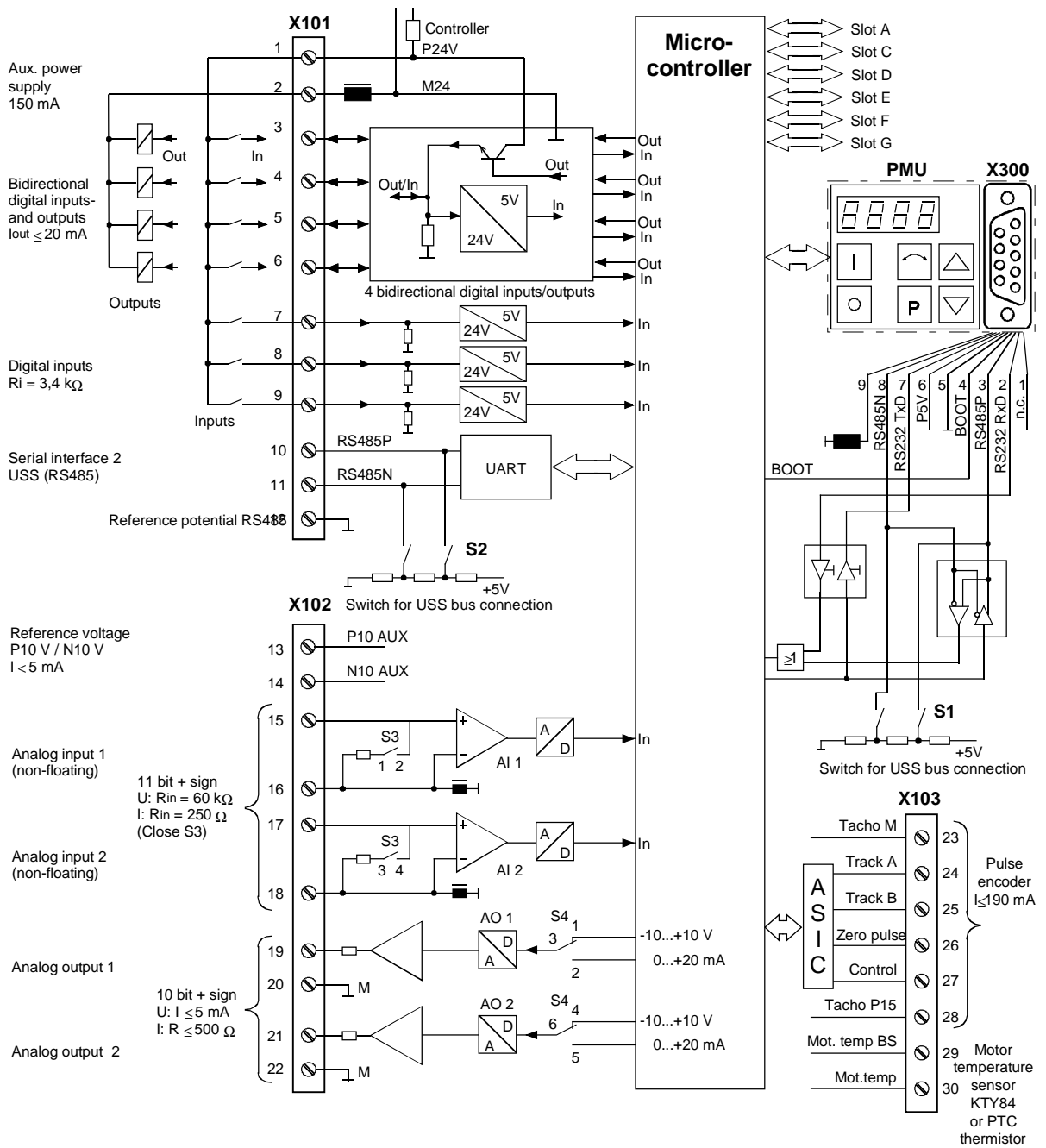
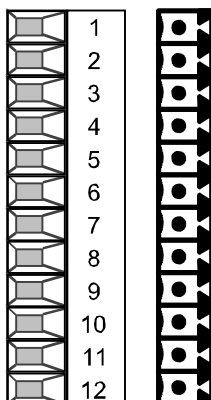

Fig. 1-2 Overview of the standard connections

X101 – Control terminal strip

The following connections are provided on the control terminal strip:

- ◆ 4 optionally parameterizable digital inputs and outputs
- ◆ 3 digital inputs
- ◆ 24 V aux. voltage supply (max. 150 mA) for the inputs and outputs
- ◆ 1 serial interface SCom2 (USS / RS485)



Terminal	Designation	Significance	Range
1	P24 AUX	Aux. voltage supply	DC 24 V / 150 mA
2	M24 AUX	Reference potential	0 V
3	DIO1	Digital input/output 1	24 V, 10 mA / 20 mA
4	DIO2	Digital input/output 2	24 V, 10 mA / 20 mA
5	DIO3	Digital input/output 3	24 V, 10 mA / 20 mA
6	DIO4	Digital input/output 4	24 V, 10 mA / 20 mA
7	DI5	Digital input 5	24 V, 10 mA
8	DI6	Digital input 6	24 V, 10 mA
9	DI7	Digital input 7	24 V, 10 mA
10	RS485 P	USS bus connection SCom2	RS485
11	RS485 N	USS bus connection SCom2	RS485
12	M RS485	Reference potential RS485	

Connectable cross-section: 1.5 mm² (AWG 16)

Terminal 1 is at the top when installed.

Table 1-1 Control terminal strip X101

X102 – Control terminal strip

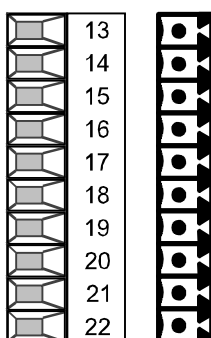

The following connections are provided on the control terminal strip:

- ◆ 10 V aux. voltage (max. 5 mA) for the supply of an external potentiometer
- ◆ 2 analog inputs, can be used as current or voltage input
- ◆ 2 analog outputs, can be used as current or voltage output

Terminal	Designation	Significance	Range
13	P10 V	+10 V supply for ext. potentiometer	+10 V ±1.3 %, I _{max} = 5 mA
14	N10 V	-10 V supply for ext. potentiometer	-10 V ±1.3 %, I _{max} = 5 mA
15	AI1+	Analog input 1 +	11 bit + sign
16	M AI1	Ground, analog input 1	<u>Voltage:</u>
17	AI2+	Analog input 2 +	± 10 V / R _i = 60 kΩ
18	M AI2	Ground, analog input 2	<u>Current:</u> R _{in} = 250 Ω
19	AO1	Analog output 1	10 bit + sign
20	M AO1	Ground, analog output 1	<u>Voltage:</u>
21	AO2	Analog output 2	± 10 V / I _{max} = 5 mA
22	M AO2	Ground, analog output 2	<u>Current:</u> 0...20 mA R ≥ 500 Ω

Connectable cross-section: 1.5 mm² (AWG 16)

Terminal 13 is at the top when installed.

Table 1-2 Control terminal strip X102

X103 – Pulse encoder connection

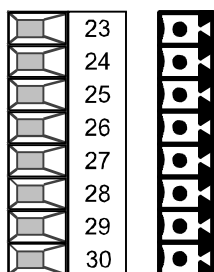

The connection for a pulse encoder (HTL unipolar) is provided on the control terminal strip.

Terminal	Designation	Significance	Range
23	- V _{SS}	Ground for power supply	
24	Track A	Connection for track A	HTL unipolar
25	Track B	Connection for track B	HTL unipolar
26	Zero pulse	Connection for zero pulse	HTL unipolar
27	CTRL	Connection for control track	HTL unipolar
28	+ V _{SS}	Power supply pulse encoder	15 V I _{max} = 190 mA
29	- Temp	Minus (-) connection KTY84/PTC	KTY84: 0...200 °C
30	+ Temp	Plus (+) connection KTY84/PTC	PTC: R _{PTC} therm ≤ 1.5 kΩ

Connectable cross-section: 1.5 mm² (AWG 16)

Terminal 23 is at the top when installed.

Table 1-3 Control terminal strip X103

X300 - Serial interface

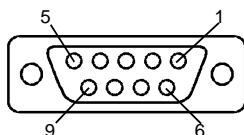

Either an OP1S or a PC can be connected up via the 9-pole Sub D socket.

Pin	Name	Significance	Range
1	n.c.	Not connected	
2	RS232 RxD	Receive data via RS232	RS232
3	RS485 P	Data via RS485	RS485
4	Boot	Control signal for software update	Digital signal, low active
5	M5V	Reference potential to P5V	0 V
6	P5V	5 V aux. voltage supply	+5 V, I _{max} = 200 mA
7	RS232 TxD	Transmit data via RS232	RS232
8	RS485 N	Data via RS485	RS485
9	n.c.	Not connected	

Table 1-4 Serial interface X300

Switch settings

Switch	Significance
S1 <ul style="list-style-type: none"> • open • closed 	SCom1 (X300): Bus terminating resistor <ul style="list-style-type: none"> • Resistor open • Resistor closed
S2 <ul style="list-style-type: none"> • open • closed 	SCom2 (X101/10,11): Bus terminating resistor <ul style="list-style-type: none"> • Resistor open • Resistor closed
S3 (1,2) <ul style="list-style-type: none"> • open • closed 	AI1: Changeover current/voltage input <ul style="list-style-type: none"> • Voltage input • Current input
S3 (3,4) <ul style="list-style-type: none"> • open • closed 	AI2: Changeover current/voltage input <ul style="list-style-type: none"> • Voltage input • Current input
S4 (1,2,3) <ul style="list-style-type: none"> • Jumper 1, 3 • Jumper 2, 3 	AO1: Changeover current/voltage output <ul style="list-style-type: none"> • Voltage output • Current output
S4 (4,5,6) <ul style="list-style-type: none"> • Jumper 4, 6 • Jumper 5, 6 	AO2: Changeover current/voltage output <ul style="list-style-type: none"> • Voltage output • Current output

1.2 Comparison of the terminals CU2 ⇒ CUVC

Terminal –X100

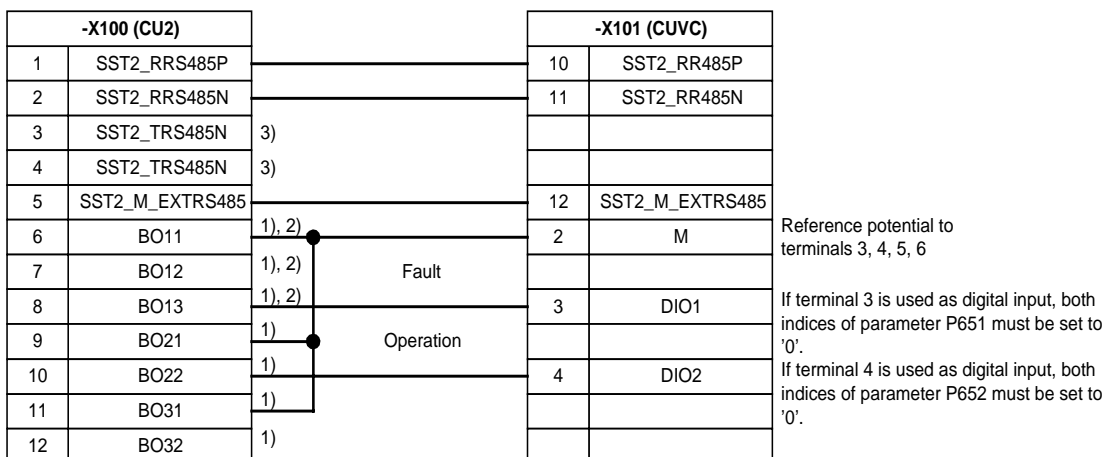

1)

If floating digital outputs are required in the application, Extension Board 2 (EB2) must be used. The CUVC digital outputs are SIMATIC compatible.

2)

If a floating relay changeover output is required in the application, Extension Board 2 (EB2) must be used.

3)

Not required, CUVC does not support a 4-wire USS protocol.

The terminal assignment shown corresponds to the basic factory setting (P366 = 0; P970 = 1).

Terminal –X101

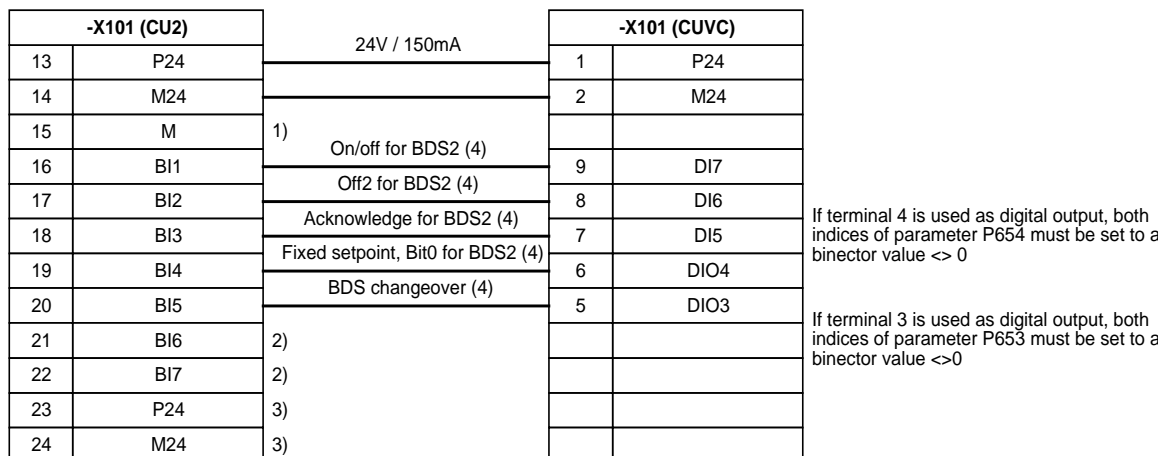

1)

Not required, terminal -X101/2 should be used.

2)

If additional digital inputs are required in the application, Extension Board 2 (EB2) must be used.

3)

Not required, terminals -X101/1 and -X101/2 should be used.

4)

The basic/reserve changeover for CU1, CU2, CU3 corresponds to the BICO data set changeover for CUVC and CUMC. There are two BICO data sets.

Terminal –X102

-X102 (CU2)			-X102 (CUVC)	
25	P10AUX	+10V / 5mA for analog inputs	13	P10AUX
26	N10AUX	-10V / 5mA for analog inputs	14	N10AUX
27	AVI1	Analog input 1, refer to 1)	15	AI1
28	AI1M	Reference potential, analog input 1	16	AI1M
29	ACI1	CUVC : Terminal -X102/15 →		
30	AVI2	Analog input 2, refer to 2)	17	AI2
31	AI2M	Reference potential, analog input 2	18	AI2M
32	ACI2	CUVC : Terminal -X102/17 →	5	
33	AO1M	Analog output 1 reference potential	20	AO1M
34	AO1	Analog output 1, refer to 3)	19	AO1

1)

S3 (1-2) open : analog input signals in the range +/-10V

S3 (1-2) closed : analog input signals in the range +/-20mA

The evaluation of the analog input signals is set in P632.1: bipolar, unipolar, 4-20mA.

For 4-20mA evaluation, the wire breakage monitoring can be activated in P638.1.

2)

S3 (3-4) open : analog input signals in the range +/-10V

S3 (3-4) closed : analog input signals in the range +/-20mA

The evaluation of the analog input signals is set in P632.2: bipolar, unipolar, 4-20mA.

For 4-20mA evaluation, the wire breakage monitoring can be activated in P638.2.

3)

S4 (1-3) closed : analog output signals in the range +/-10V

S4 (2-3) closed : analog output signals in the range 0-20mA

Terminal –X103

-X103 (CU2)			-X103 (CUVC)	
35	MTACHO	Tachometer, reference potential	23	MTACHO
36	ATACHO	Tachometer signal, track A (HTL)	24	ATACHO
37	BTACHO	Tachometer signal, track B (HTL)	25	BTACHO
38	NULLTACHO	Tachometer signal, zero track (HTL)	26	NULLTACHO
39	CTRLTACHO	Tachometer monitoring signal (HTL)	27	CTRLTACHO
40	P15TACHO	Tachometer power supply (15 V / 150 mA)	28	P15TACHO
41	MOTEMPM	Motor temperature sensor, reference potential	29	MOTEMPM
42	MOTEMP	Motor temperature sensor	29	MOTEMP
...				
43	AO2M	Analog output 2, reference potential	-X102 (CUVC)	
44	AO2	Analog output 2	22	AO2M
			21	AO2

1)

PTC- and KTY84 motor temperature sensors can be connected to this terminal.

The temperature sensor type is determined in parameter P380 by entering the threshold values.

2)

S4 (4-6) closed : analog output signals in the range +/-10V

S4 (5-6) closed : analog output signals in the range 0-20mA

2 EB2 – Expansion Board

2.1 Definitions and Warnings

Qualified personnel For the purpose of this documentation and the product warning labels, a "Qualified person" is someone who is familiar with the installation, mounting, start-up, operation and maintenance of the product. He or she must have the following qualifications:

- ◆ Trained or authorized to energize, de-energize, ground and tag circuits and equipment in accordance with established safety procedures.
- ◆ Trained or authorized in the proper care and use of protective equipment in accordance with established safety procedures.
- ◆ Trained in rendering first aid.



DANGER

For the purpose of this documentation and the product warning labels, "Danger" indicates death, severe personal injury or substantial property damage will result if proper precautions are not taken.



WARNING

For the purpose of this documentation and the product warning labels, "Warning" indicates death, severe personal injury or property damage can result if proper precautions are not taken.



CAUTION

For the purpose of this documentation and the product warning labels, "Caution" indicates that minor personal injury or material damage can result if proper precautions are not taken.

NOTE

For the purpose of this documentation, "Note" indicates important information about the product or about the respective part of the documentation which is essential to highlight.



WARNING

- ◆ Hazardous voltages are present in this electrical equipment during operation.
- ◆ Non-observance of the warnings can thus result in severe personal injury or property damage.
- ◆ Only qualified personnel should work on or around the equipment
- ◆ This personnel must be thoroughly familiar with all warning and maintenance procedures contained in this documentation.
- ◆ The successful and safe operation of this equipment is dependent on correct transport, proper storage and installation as well as careful operation and maintenance.

**CAUTION**

Components which can be destroyed by electrostatic discharge (ESD)

The board contains components which can be destroyed by electrostatic discharge. These components can be easily destroyed if not carefully handled. If you have to handle electronic boards, please observe the following:

- ◆ Electronic boards should only be touched when absolutely necessary.
- ◆ The human body must be electrically discharged before touching an electronic board.
- ◆ Boards must not come into contact with highly insulating materials - e.g. plastic parts, insulated desktops, articles of clothing manufactured from man-made fibers.
- ◆ Boards must only be placed on conductive surfaces.
- ◆ Boards and components should only be stored and transported in conductive packaging (e.g. metalized plastic boxes or metal containers).
- ◆ If the packing material is not conductive, the boards must be wrapped with a conductive packaging material, e.g. conductive foam rubber or household aluminium foil.

The necessary ESD protective measures are clearly shown in the following diagram:

- ◆ a = Conductive floor surface
- ◆ b = ESD table
- ◆ c = ESD shoes
- ◆ d = ESD overall
- ◆ e = ESD chain
- ◆ f = Cubicle ground connection

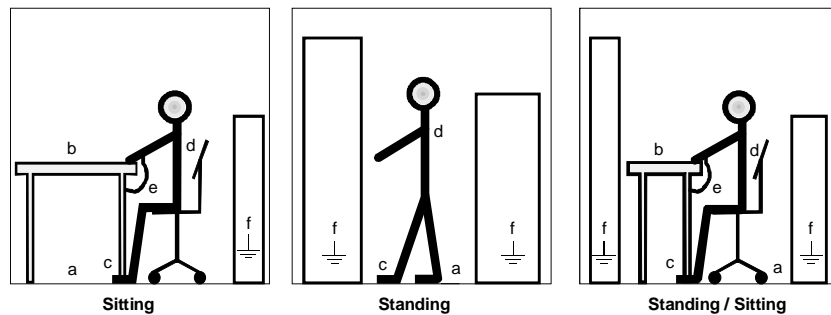

Fig. 2-1 ESD protective measures

2.2 Description

Range of application

The digital and analog inputs and outputs can be expanded with Expansion Board 2 (EB2).

The EB2 optional board has the following:

- ◆ 2 digital inputs
- ◆ 24 V voltage supply for the digital inputs
- ◆ 1 relay output with changeover contacts
- ◆ 3 relay outputs with NO contact
- ◆ 1 analog input with differential signal, which can be used as a current input and as a voltage input
- ◆ 1 analog output which can be used as a current output and as a voltage output

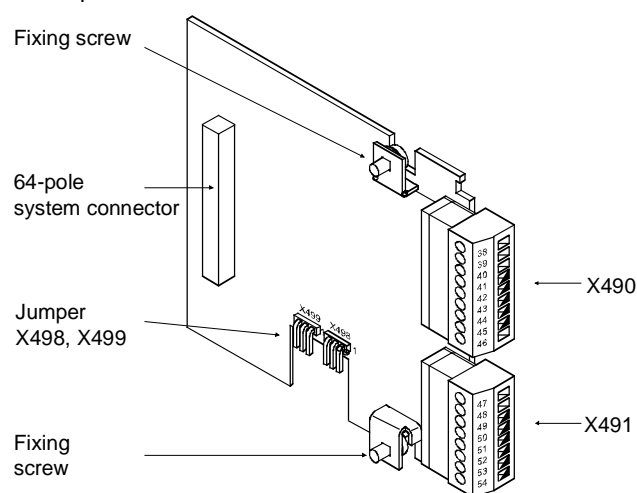

Fig. 2-2 View of the EB2 optional board

2.3 Technical Data

Order number	6SE7090-0XX84-0KC0
Size (length x width)	90 mm x 83 mm
Pollution degree	Pollution degree 2 acc. to IEC 664-1 (DIN VDE 0110/T1), moisture condensation is not permissible in operation
Mechanical strength During stationary operation - Deflection - Acceleration During transport - Deflection - Acceleration	Acc. to DIN IEC 68-2-6 (for correctly installed board) 0.15 mm in frequency range 10 Hz to 58 Hz 19.6 m/s ² in frequency range > 58 Hz to 500 Hz 3.5 mm in frequency range 5 Hz to 9 Hz 9.8 m/s ² in frequency range > 9 Hz to 500 Hz
Climate class	Class 3K3 to DIN IEC 721-3-3 (in operation)
Type of cooling	Natural-air cooling
Permissible ambient or coolant temperature - during operation - during storage - during transport	0° C to +70° C (32° F to 158° F) -25° C to +70° C (-13° F to 158° F) -25° C to +70° C (-13° F to 158° F)
Permissible humidity rating	Relative air humidity ≤ 95 % during transport and storage ≤ 85 % in operation (condensation not permissible)

Table 2-1 General technical data

Digital inputs	DI1, DI2, DIM
<ul style="list-style-type: none"> • Voltage range LOW • Voltage range HIGH • Input resistance • Smoothing • Electrical isolation 	0 V (- 33 V ... + 5 V) + 24 V (+ 13 V ... + 33 V) 4 kΩ 250 μs none
Digital outputs (relay)	DO1, DO2, DO3, DO4
<ul style="list-style-type: none"> • Type of contact • Max. switching voltage • Max. switching capacity - at 60 V AC: - at 60 V DC: • Necessary minimum load 	Changeover / NO contact 60 V AC, 60 V DC 16 VA (cos φ = 0,4) 60 VA (cos φ = 1,0) 3 W (cos φ = 0,4) 24 W (cos φ = 1,0) 1 mA, 1 V

Analog input (differential input)	AI1P, AI1N
<ul style="list-style-type: none"> • Input range <li style="padding-left: 20px;">Voltage <li style="padding-left: 20px;">Current • Input resistance <li style="padding-left: 20px;">Voltage <li style="padding-left: 20px;">Current • Hardware smoothing • Resolution 	<ul style="list-style-type: none"> $\pm 10.0 \text{ V}$ ($\pm 1 \text{ V}$ reserve) $\pm 20 \text{ mA}$ ($\pm 2 \text{ mA}$ reserve) 40 kΩ to ground 250 Ω to ground 200 μs 11 bit + sign
Analog output Current or voltage signal	AO, AOM
<ul style="list-style-type: none"> • Voltage signal • Current signal • Hardware smoothing • Resolution 	<ul style="list-style-type: none"> $\pm 10.0 \text{ V} / \pm 5 \text{ mA}$ $\pm 20 \text{ mA}$ at 500 Ω 10 μs 9 bit + sign

Table 2-2 Technical data of EB2

2.4 Installation

If the inverters/converters are ordered with optional functions, the optional boards are already installed in the units when they are delivered.

It is possible to retrofit optional boards and this can be carried out by the user.

For this purpose, there are either three or up to six slots on the basic unit depending on the type of construction for mounting the optional boards.

An exact description of installation is included with the relevant basic unit. As the unit has to be removed and opened in order to install optional boards, attention must be paid to the ESD measures. Please refer to the operating instructions of the basic unit in this regard.

NOTE

Generally, you can install the EB2 optional board in every slot. However, bear in mind that a sensor board always requires slot C.

A maximum of two EB2s can be installed per unit.

2.5 Connecting-up

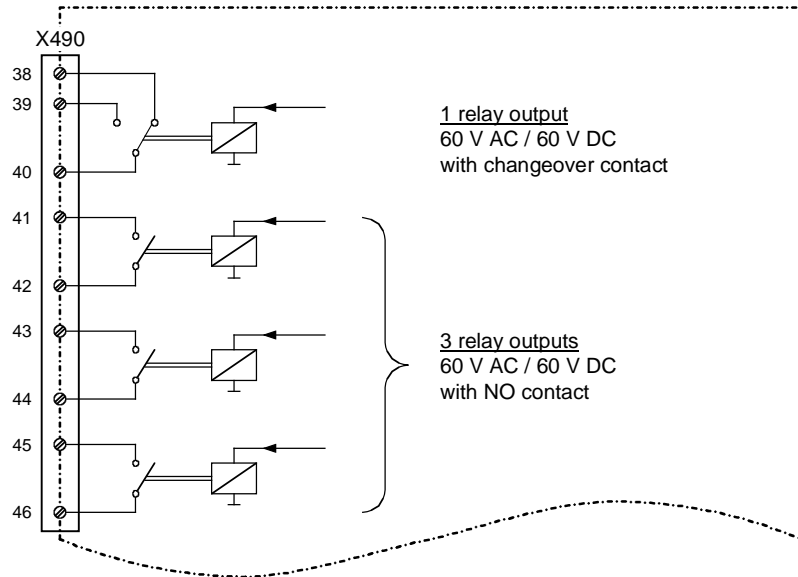

Fig. 2-3 X490 connection overview

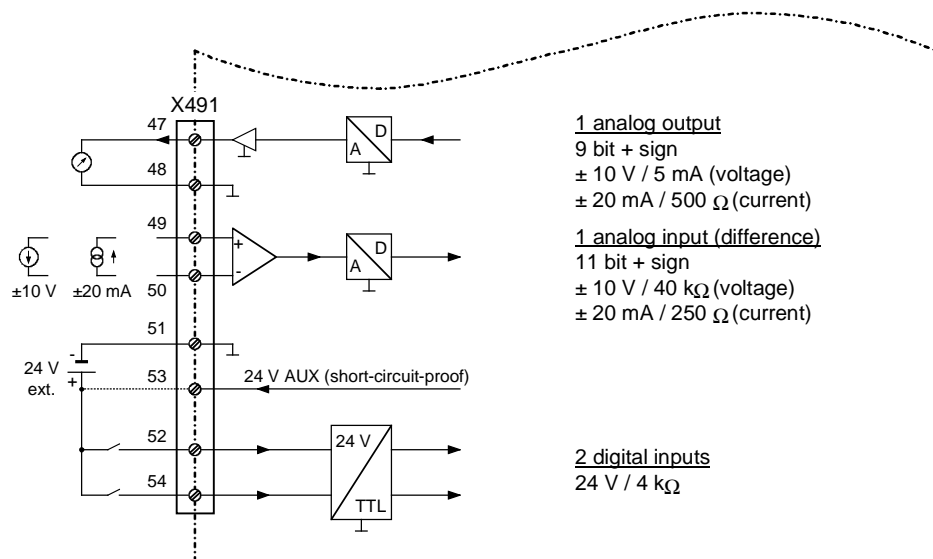
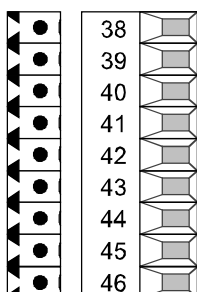

Fig. 2-4 X491 connection overview

X490 - Relay outputs



The following connections are provided on the terminal strip:

- ◆ 1 relay output (changeover contact)
- ◆ 3 relay outputs (NO contact)

Terminal	Designation	Significance
38	DO13	Relay output 1, NC contact
39	DO12	Relay output 1, NO contact
40	DO11	Relay output 1, reference contact
41	DO22	Relay output 2, NO contact
42	DO21	Relay output 2, reference contact
43	DO32	Relay output 3, NO contact
44	DO31	Relay output 3, reference contact
45	DO42	Relay output 4, NO contact
46	DO41	Relay output 4, reference contact

Connectable cross-section: 1.5 mm² (AWG 16)

Terminal 38 is at the top when installed.

Table 2-3 Terminal assignment at connection X490

X491 - Analog input and output, digital inputs

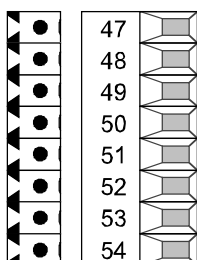

There are the following connections on the terminal strip:

- ◆ 1 analog input (current or voltage)
- ◆ 1 analog output (current or voltage)
- ◆ 2 digital inputs

Terminal	Designation	Significance	Range
47	AO	Analog output	Voltage: ± 10 V, 5 mA
48	AOM	Ground analog output	Current: ± 20 mA, 500 Ω
49	AI1P	Analog input +	Voltage: ± 10 V, 40 kΩ
50	AI1N	Analog input -	Current: ± 20 mA, 250 Ω
51	DIM	Ground digital input	0 V
52	P24AUX	24 V supply	24 V, 150 mA
53	DI1	Digital input 1	24 V, 4 kΩ
54	DI2	Digital input 2	24 V, 4 kΩ

Connectable cross-section: 1.5 mm² (AWG 16)

The ground cables are protected by a reactor.

Terminal 47 is at the top when installed.

Table 2-4 Terminal assignment of connection X491

NOTE

The current which is output via connection P24AUX - total current of all optional boards - must not exceed 150 mA!

Loadability of the relay contacts:

Type of contact	Changeover contact
Maximum switching voltage	60 V AC, 60 V DC
Maximum switching capacity	16 VA at 60 V AC (cos $\varphi = 0.4$) 60 VA at 60 V AC (cos $\varphi = 1.0$) 3 W at 60 V DC (cos $\varphi = 0.4$) 24 W at 60 V DC (cos $\varphi = 1.0$)
Required minimum load	1 mA, 1 V

Jumper settings

The analog input can be used as a voltage input or as a current input. The analog output can be used as a voltage output or as a current output.

Switchover is made via jumpers on the lower section of the board. The assignment is shown in the following table:

Connector	Significance
X498 • Jumper 1 + 2 • Jumper 2 + 3	Current/voltage input switchover at AI1 • Current input • Voltage input
X499 • Jumper 1 + 2 • Jumper 2 + 3	Current/voltage output switchover at AO • Current output • Voltage output

Table 2-5 Jumper settings

2.6 Start-up

After installation of the EB2 terminal expansion board has been completed, an automatic self-test is carried out when the basic unit (converter/inverter) is powered up.

If you want to use an input or output of the optional board, you have to activate the respective function block.

NOTES

Please bear in mind that if two EB2 terminal expansions are installed, each board is provided with its own parameter set.

Please refer to the Compendium for further information regarding parameterization of the EB2 terminal expansion board.

3 Function blocks and parameters

Control functions A large number of open-loop and closed-loop control functions, communication functions, as well as diagnostics and operator control functions are implemented in the software of the converters and inverters by means of function blocks. These function blocks can be parameterized and freely interconnected.

The interconnection method can be compared with electrical circuit engineering where various function units, e.g. integrated circuits or other components are interconnected by cables.

The difference is, however, that function blocks are interconnected not by cables, but via software.

3.1 Function blocks

Functions are implemented in function blocks. The function scope of the individual function blocks depends on its special task.

The function blocks are provided with inputs, outputs and parameters and are processed in time slots.

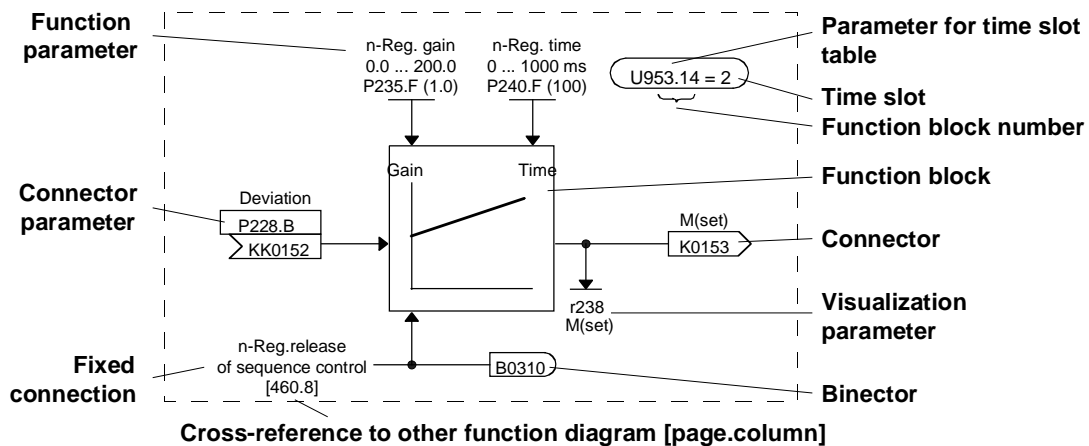

Fig. 3-1 A function block

Function block number

Each function block has a function block number (FB number) by which it can be clearly identified. With the FB number, you can define which time slot can be used for processing a large number of function blocks. For this purpose, each function block is allocated an indexed parameter which contains the relevant FB number in its parameter number and its parameter index.

Example:

U950.01 is the code of FB number 001
 U953.50 is the code of FB number 250
 U953.99 is the code of FB number 299
 U954.74 is the code of FB number 374

The parameter for selecting the time slot as well as the corresponding factory setting are indicated in the function diagrams for each function block. This data takes the form of an ellipse in order to distinguish it optically from the other elements of a function block.

In addition to the time slot, the processing sequence can also be determined for most of the function blocks.

3.2 Connectors and binectors

Connectors and binectors are elements which are used to exchange signals between individual function blocks. They are each cyclically filled by function blocks with one signal value. Other function blocks can then call up these values, depending on parameterization.

Connectors

Connectors can be likened to storage locations which are used to archive "analog" signals. They are clearly designated. Each connector designation comprises the connector name, the connector number and an identification letter.

The identification letter depends on the numerical representation:

- ◆ K Connector with word length (16 bit)
- ◆ KK Connector with double-word length (32 bit, increased accuracy)

The connector number always has four digits.

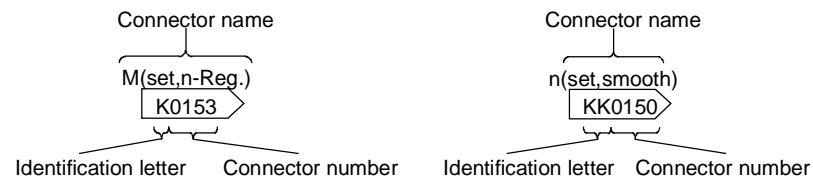

Fig. 3-2 Connectors with word lengths of 16 bit and 32 bit

Value range of the connectors

The values stored in the connectors are normalized values, with a few exceptions (e.g. connectors for control words).

The value range of these connectors covers a percentage value range of:

- ◆ -200 % (8000H / 8000 0000H for double-word connectors) to
- ◆ +199,99 % (7FFFH / 7FFF FFFFH for double-word connectors).

100 % corresponds to the value 4000H (4000 0000H for double-word connectors).

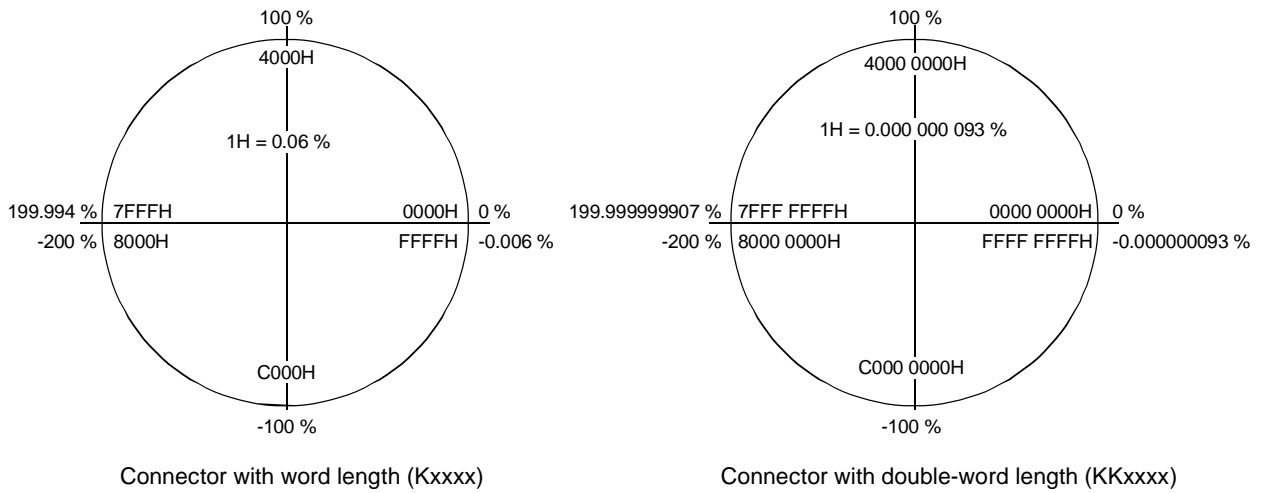

Fig. 3-3 Value range and assignment of the figure ranges for connectors

Binectors

Function blocks archive the **binary** (digital) output information in binary **connectors**, the binectors. Binectors can therefore be likened to storage locations used for storing binary signals. They are clearly identified. Each binector designation comprises the binector name, the binector number and an identification letter. The identification letter is B. The binector number always has four digits.

On account of their definition, binectors can only assume the two states "0" (logically no) and "1" (logically yes).

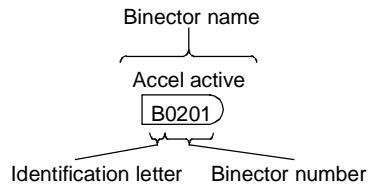

Fig. 3-4 Binectors

3.3 Parameters

Parameters are the intervention points for adapting function blocks to an application, for interconnecting function blocks via connectors and binectors and for visualizing internal signals.

The various parameters are differentiated according to their function as follows:

- ◆ Function parameters (can be read and written)
- ◆ BICO parameters (can be read and written)
- ◆ Visualization parameters (can only be read).

Each parameter is clearly designated. The parameter designation comprises the parameter name and the parameter number, and enables every parameter to be clearly identified. In addition to the parameter name and the parameter number, many parameters also have a parameter index. With the aid of this index, it is possible to store several values for one parameter under one parameter number.

The function diagrams indicate the factory setting for every BICO parameter and every function parameter. They further indicate the value ranges for the changeable function parameters.

Parameter numbers on the PMU

The parameter numbers shown on the parameterizing unit (PMU) which is directly mounted on the unit consist of a letter and a three-digit number.

The following applies for the letters:

- ◆ Upper-case letters (P, U, H and L) represent the BICO parameters and function parameters which can be changed
- ◆ Lower-case letters (r, n, d and c) represent the visualization parameters which cannot be changed.

The three-digit number covers the value range from 000 to 999; but not all values are used.

Parameter numbers on the OP1S

The OP1S operator control panel enables parameters to be selected directly by their parameter numbers. As the OP1S only has a numerical keypad, the parameter number must be replaced by a figure when input. The following replace mode is applicable:

- ◆ "P"xxx and "r"xxx are replaced by "0"xxx
- ◆ "H"xxx and "d"xxx are replaced by "1"xxx
- ◆ "U"xxx and "n"xxx are replaced by "2"xxx
- ◆ "L"xxx and "c"xxx are replaced by "3"xxx

Examples:

Select r004 on OP1S: Input 0004
 Select P050 on OP1S: Input 0050
 Select U123 on OP1S: Input 2123
 Select L411 on OP1S: Input 3411

Function parameters The response of a function block is determined by function parameters. Typical examples of function parameters are:

- ◆ Normalization of an input signal
- ◆ Acceleration or deceleration times in the ramp-function generator
- ◆ Proportional gain (Kp) and integral time (Tn) in the speed controller.

Function parameters can be indexed. The significance of the parameter values stored in the various indices depends on the definition of the respective parameter. A special group is formed by the function parameters which are part of the so-called function data sets.

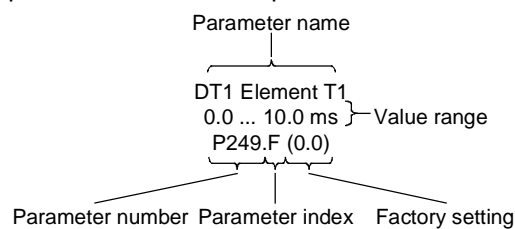

Fig. 3-5 Function parameters

Function data sets (Setpoint data sets) Special function parameters are put together in function data sets. These parameters are marked in the function diagrams with the parameter index **.F**.

The parameters concerned are indexed four-fold, which means that one parameter value can be stored under each parameter index, i.e. a total of four parameter values can be stored.

The active function data set determines which value is currently being used. If function data set 1 is active, the parameter value stored in parameter index 1 is used. If function data set 2 is active, the parameter value stored in parameter index 2 is used, etc.

Example:

P462.1 = 0.50
P462.2 = 1.00
P462.3 = 3.00
P462.4 = 8.00

A total of 4 values are stored under parameter P462 (Accel Time). If function data set 1 is active, the acceleration time is 0.50 secs. If function data set 2 is active, the acceleration time is 1.00 secs. If function data set 3 is active, the acceleration time is 3.00 secs and if function data set 4 is active, the acceleration time is 8.00 secs.

The individual function data sets are selected by means of control word bits 16 and 17 in control word 2 (P576.B and P577.B). Changeover is possible at any time.

The active function data sets are displayed via the visualization parameter r013 (Active FuncDSet).

NOTE

Changeover of all the indexed parameters of the function data sets between parameter indices 1, 2, 3 and 4 is always effected jointly.

Motor parameters

The motor parameters enable the converter to be adapted to the connected motor and enable the open-loop and closed-loop control structure to be adapted. Typical examples for motor parameters are:

- ◆ Rated motor data from the rating plate
- ◆ Specification of the connected tachometer
- ◆ Current and output limits

Motor parameters are indexed 4-fold.

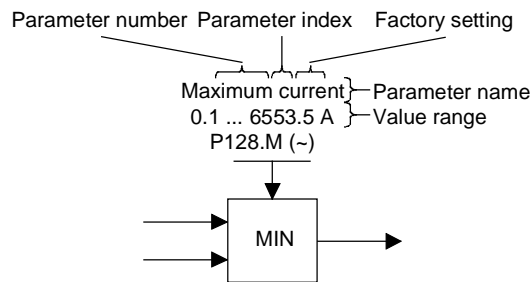

Fig. 3-6 Motor parameters

Motor data sets

Selected function parameters are put together in motor data sets. These parameters are marked in the function diagrams with the parameter index **.M**

The parameters concerned are indexed four-fold, which means that one parameter value can be stored under each parameter index of these parameters, i.e. a total of four parameters can be stored.

The active motor data block (MDS) determines which value is currently being used. If MDS1 is active, the parameter value stored in parameter index 1 is used, if MDS2 is active, the parameter value stored in parameter index 2 is used, etc

Example:

P100.1 = 4
 P100.2 = 3
 P100.3 = 1
 P100.4 = 1

A total of 4 values are stored under parameter P100 (Control Mode). If motor data set 1 is active, the drive operates in speed control with a tachometer. If the motor data set 2 is active, the drive operates in frequency control without a tachometer. If motor data set 3 and 4 are active, the drive operates in v/f control.

Individual motor data sets are selected via control word bits 18 and 19 in control word 2 (P578.B and P579.B).

Changeover is only possible in the powered-down state.

NOTE

All indexed parameters of the motor data sets are always changed over jointly between parameter indices 1, 2, 3 and 4.

BICO parameters

With BICO parameters, you can determine the sources of the input signals of a function block. This means that you can use BICO parameters to define the connectors and binectors from which a function block reads in its input signals. In this manner, you can "soft-wire" the function blocks stored in the units to meet your requirements. This is referred to as the BICO system.

For every BICO parameter, the type of input signals (connector or binector) which you can connect to the inputs is specified. BICO parameters have the following identification:

- ◆ B Binector parameter
for connecting binectors
- ◆ K Connector parameter
for connecting connectors with word length (16 bit)
- ◆ KK Connector parameter
for connecting connectors with double-word length (32 bit)

Reciprocal "softwiring" of binectors and connectors is not permitted. However, you can always connect connector with word length and double-word length to the connector parameters.

BICO parameters are available in two forms; they can either be

- ◆ non-indexed, or
- ◆ double-indexed.

**BICO data sets
(Basic/reserve data sets)**

Selected BICO parameters are put together in BICO data sets. These parameters are marked in the function diagrams with the parameter index **.B**.

The parameters concerned are double-indexed, which means that one parameter value can be stored under each parameter index of these parameters, i.e. a total of two parameter values can be stored.

The active BICO data set determines which value is currently being used. If BICO data set 1 is active, the parameter value stored in parameter index 1 is used. If BICO data set 2 is active, the parameter value stored in parameter index 2 is used.

Example:

P554.1 = 10
P554.2 = 2100

A total of 2 values are stored under parameter P554 (Src ON/OFF1). If BICO data set 1 is active, the ON command comes from digital input 1 of the basic unit. If BICO data set 2 is active, the ON command comes from bit 0 of the first data word received by serial interface 1.

Individual BICO data sets are selected by means of control word bit 30 in control word 2 (P590).

The active BICO data set is displayed via visualization parameter r012 (Active BICO DS).

NOTE

All indexed BICO parameters are always switched jointly between parameter index 1 and 2.

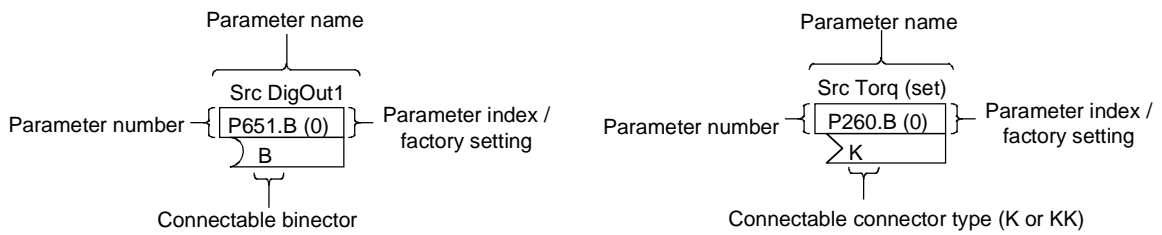

Fig. 3-7 Connectors with word lengths of 16 bit and 32 bit

Visualization parameters

Visualization parameters are used for visualizing internal quantities (e.g. applicable output current). These parameters are only displayed and cannot be changed by you.

To distinguish them from the other parameters, they are designated with a lower-case letter (r, n, d and c) in the parameter number.

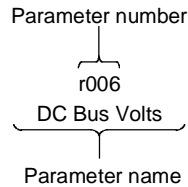

Fig. 3-8 Visualization parameters

3.4 Connecting up function blocks (BICO system)

BICO system is the term used to describe the method of creating connections between function blocks. This is performed with the aid of **binectors** and **connectors**. The name **BICO** system is derived from these two terms.

A connection between two function blocks consists of a connector or binector on the one side, and a BICO parameter on the other side. The connection is always made from the point of view of the input of a function block. You must always assign an output to an input.

Assignment is made by entering in a BICO parameter the number of the connector or the binector from which the required input signals are read in. You are allowed to enter the same connector and binector numbers several times in different BICO parameters and thus use output signals of one function block as input signals for several other function blocks.

Example:

In the following figure, connector K0152 is connected to connector parameter P228. For this purpose, you must assign the number of connector K0152 as the value to the connector parameter P228, i.e. in this case 152.

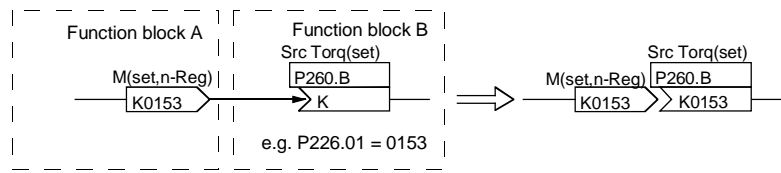

Fig. 3-9 Connecting two function blocks

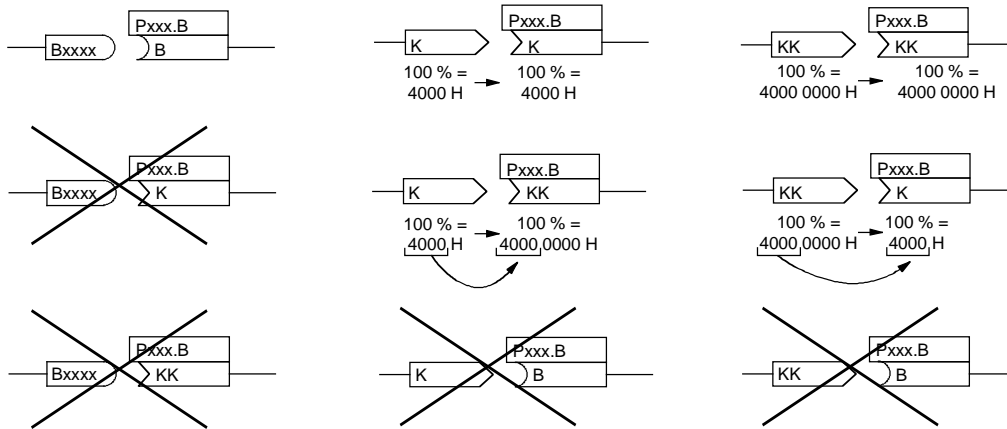

Fig. 3-10 Possible and impossible BICO connections

Interconnecting different connector types

Depending on their characteristics, connectors either have a length of a word (16 bit) or a double-word (32 bit). Accordingly, function blocks have BICO parameters which are suitable for connecting the respective connector type. It is, however, possible in principle to mix the types among the connectors. The word length is then automatically adjusted according to the following mode:

Interconnection of a word connector to	a word connector parameter	Value stays the same
	a double-word connector parameter	Value is taken over in high-word, low-word is filled up with 0000H
Interconnection of a double-word connector to	a word connector parameter	Value is taken over from high-word, low-word deleted
	a double-word connector parameter	Value stays the same

NOTE

When a double-word connector is interconnected to a word connector parameter, the signal resolution will drop from 32 bit to 16 bit. As the low-word is cut off, the information of the lower-order 16 bit of the double-word connectors is then lost.

4 Start-up

4.1 Parameter reset to factory setting

The factory setting is the defined initial state of all parameters of a unit. The units are delivered with this setting.

You can restore this initial state at any time by resetting the parameters to the factory setting, thus canceling all parameter changes made since the unit was delivered.

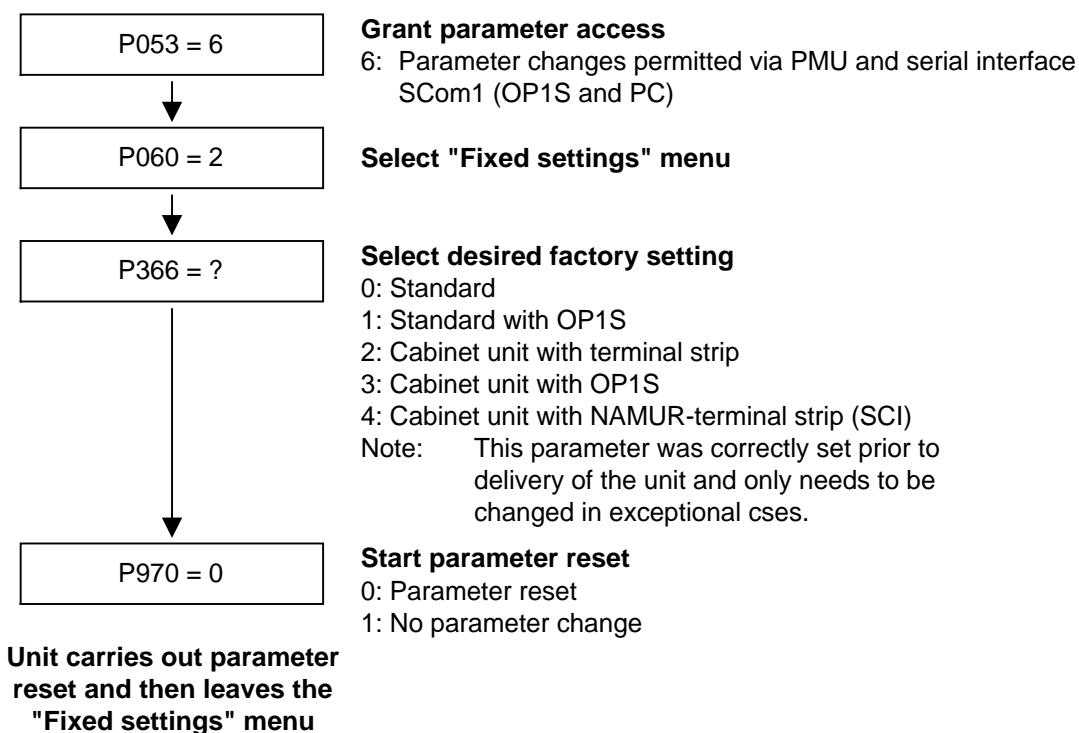

Fig. 4-1 Sequence for parameter reset to factory setting

Factory settings dependent on P366

Parameters dependent on P366	Designation of the parameter on the OP1S	Normal factory setting		Factory setting with OP1S		Cabinet unit with OP1S		Cabinet unit with terminal strip		Cabinet unit with NAMUR terminal strip (SCI)	
		P366 = 0		P366 = 1		P366 = 2		P366 = 3		P366 = 4	
		BICO1 (i001)	BICO2 (i002)	BICO1 (i001)	BICO2 (i002)	BICO1 (i001)	BICO2 (i002)	BICO1 (i001)	BICO2 (i002)	BICO1 (i001)	BICO2 (i002)
P443	Src MainSetpoint	KK058	KK040	KK040	KK040	KK040	KK040	KK058	KK040	KK058	K4101
P554	Src ON/OFF1	B0005	B0022	B2100	B0022	B2100	B0022	B0005	B0022	B2100	B4100
P555	Src1 OFF2(coast)	B0001	B0020	B0001	B0020	B0001	B0001	B0001	B0001	B0001	B0001
P556	Src2 OFF2(coast)	B0001	B0001	B0001	B0001	B0001	B0001	B0001	B0001	B0001	B4108
P565	Src1 Fault Reset	B2107	B2107	B2107	B2107	B2107	B2107	B2107	B2107	B2107	B2107
P566	Src2 Fault Reset	B0000	B0000	B0000	B0000	B0000	B0000	B0000	B0000	B4107	B4107
P567	Src3 Fault Reset	B0000	B0018	B0000	B0018	B0000	B0010	B0000	B0010	B0000	B0018
P568	Src Jog Bit0	B0000	B0000	B2108	B0000	B2108	B0000	B0000	B0000	B0000	B0000
P571	Src FWD Speed	B0001	B0001	B2111	B0001	B2111	B0001	B0001	B0001	B0001	B0001
P572	Src REV Speed	B0001	B0001	B2112	B0001	B2112	B0001	B0001	B0001	B2112	B4109
P573	Src MOP UP	B0008	B0000	B0008	B0000	B0008	B0000	B0008	B0000	B2113	B4105
P574	Src MOP Down	B0009	B0000	B0009	B0000	B0009	B0000	B0009	B0000	B2114	B4106
P575	Src No ExtFault1	B0001	B0001	B0001	B0001	B0018	B0018	B0018	B0018	B0001	B0001
P588	Src No Ext Warn1	B0001	B0001	B0001	B0001	B0020	B0020	B0020	B0020	B0001	B0001
P590	Src BICO DSet	B0014	B0014	B0014	B0014	B0012	B0012	B0012	B0012	B4102	B4102
P651	Src DigOut1	B0107	B0107	B0107	B0107	B0000	B0000	B0000	B0000	B0107	B0107
P652	Src DigOut2	B0104	B0104	B0104	B0104	B0000	B0000	B0000	B0000	B0104	B0104
P653	Src DigOut3	B0000	B0000	B0000	B0000	B0107	B0107	B0107	B0107	B0000	B0000
P693.1	SCI AnaOutActV 1	KK000	KK000	KK000	KK000	KK000	KK000	KK000	KK000	KK020	KK020
P693.2	SCI AnaOutActV 2	K0000	K0000	K0000	K0000	K0000	K0000	K0000	K0000	K0022	K0022
P693.3	SCI AnaOutActV 3	K0000	K0000	K0000	K0000	K0000	K0000	K0000	K0000	K0024	K0024
P698.1	Src SCI DigOut 1	B0000	B0000	B0000	B0000	B0000	B0000	B0000	B0000	B4100	B4100
P698.2	Src SCI DigOut 2	B0000	B0000	B0000	B0000	B0000	B0000	B0000	B0000	B0120	B0120
P698.3	Src SCI DigOut 3	B0000	B0000	B0000	B0000	B0000	B0000	B0000	B0000	B0108	B0108
P698.4	Src SCI DigOut 4	B0000	B0000	B0000	B0000	B0000	B0000	B0000	B0000	B0107	B0107
P704.3	SCom TlgOFF SCI	0 ms	0 ms	0 ms	0 ms	0 ms	0 ms	0 ms	0 ms	100ms	100ms
P796	Compare Value	100.0	100.0	100.0	100.0	100.0	100.0	100.0	100.0	2.0	2.0
P797	Compare Hyst	3.0	3.0	3.0	3.0	3.0	3.0	3.0	3.0	1.0	1.0
P049.4	OP OperDisp	229	229	405	405	405	405	229	229	229	229

4.2 Detailed parameterization

Detailed parameterization should always be used in cases where the application conditions of the units are not exactly known beforehand and detailed parameter adjustments need to be carried out locally. An example of a typical application is initial start-up.

4.2.1 Power section definition

During the power section definition, the control electronics is informed which power section it is working with. This step is necessary for Compact, chassis and cabinet units. On these units, the CUVC control board is accommodated in the electronics box and is not firmly connected to the power section.

The power section definition has already been completed in the as-delivered state. It therefore only needs to be carried out if the CUVC needs replacing, and is not required under normal circumstances.

WARNING



If CUVC boards are changed over between different units without the power section being re-defined, the unit can be destroyed when connected up to the voltage supply and energized.

The unit has to be switched to the "Power section definition" state for carrying out the power section definition. This is done by selecting the "Power section definition" menu. The power section is then defined in this menu by inputting a code number.

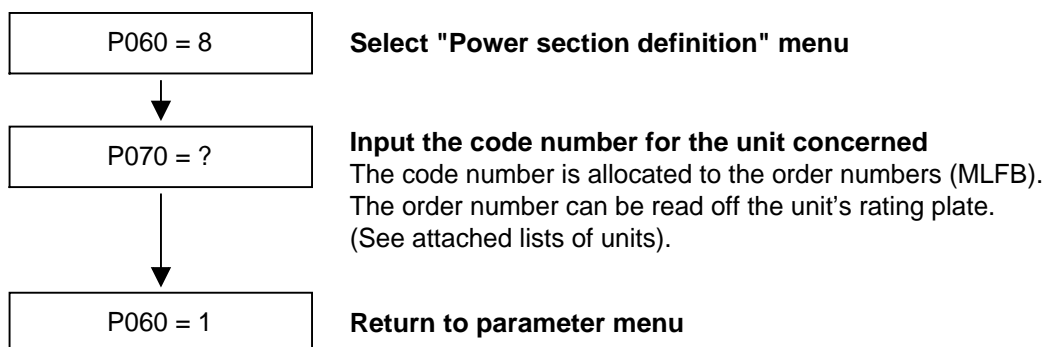

Fig. 4-2 Sequence for performing the power section definition

NOTE

To check the input data, the values for the converter supply voltage in P071 and the converter current in P072 should be checked after returning to the parameter menu. They must tally with the data given on the unit rating plate.

4.2.2 Board configuration

in preparation

4.2.3 Drive setting

During the drive setting, the control electronics is informed about the incoming voltage supply with which the drive converter is operating, about the connected motor and about the motor encoder. In addition, the motor control (V/f open-loop control or closed-loop current control) and the pulse frequency are selected. If required, the parameters necessary for the motor model can be calculated automatically. Furthermore, the normalization values for current, voltage, frequency, speed and torque signals are determined during the drive setting.

For start-up of the induction motor, first enter the manufacturer's parameters completely (see below):

- ◆ In doing so, you must observe whether the induction motor has a star or a delta connection.
- ◆ You must always use the S1 data from the rating plate.
- ◆ You must enter the rating data for mains duty (not converter duty).
- ◆ You must always enter the correct rated motor current P102 (rating plate). If there are two different rated currents on the rating plate for special fan motors, you must use the value for M ~ n for constant torque (not M ~ n2). A higher torque can be set with the torque and active-current limits.
- ◆ The accuracy of the rated motor current has a direct effect on the torque accuracy, as the rated torque is normalized to the rated current. If a rated current is increased by 4 %, this will also approximately result in a 4 % increase in the torque (referred to the rated motor torque).
- ◆ For group drives, you have to enter the total rated current $P102 = x \cdot I_{mot, nenn}$
- ◆ If the rated magnetizing current is known, you should enter it during the drive setting in P103 (in % $I_{mot, nenn}$). If this is done, the results of the "Automatic parameterization" (P115 = 6) will be more precise.
- ◆ As the rated magnetizing current P103 (not to be confused with the no-load current during operation with rated frequency P107 and rated voltage P101) is usually not known, you can first enter 0.0 %. With the aid of the power factor (cosPHI) P104, an approximate value is calculated and displayed in r119.
Experience shows that the approximation supplies values which are rather on the large side in the case of motors with a high rating (over 800 kW), whereas it supplies values which are slightly too low in the case of motors with low rating (below 22 kW).
The magnetizing current is defined as a field-generating current component during operation at the rated point of the machine ($U = P101, f = P107, n = P108, i = P102$).
- ◆ The rated frequency P107 and the rated speed P108 automatically result in the calculation of the pole pair number P109. If the connected motor is designed as a generator and the generator data are on the rating plate (oversynchronous rated speed), you have to correct the pole pair number manually (increase by 1 if the motor is at least 4-pole), so that the rated slip (r110) can be correctly calculated.

- ◆ For induction motors, you have to enter the actual rated motor speed, and not the synchronous no-load speed in P108, i.e. the slip frequency at nominal load has to be derived from parameters P107...P109.
- ◆ The rated motor slip ($1 - P108/60 \times P109/P107$) should usually be greater than $0.35 \% \times P107$.
These low values are, however, only achieved in the case of motors with a very high rating (from approx. 1000 kW).
Motors with average rating (45..800 kW) have slip values around 2.0...0.6 %.
Motors with low rating (below 22 kW) can also have slip values up to 10 %.
- ◆ It is possible to achieve a more accurate evaluation of the rated slip after standstill measurement (P115 = 2) by taking into account the temperature evaluation for the rotor resistance P127.
On cold motors (approx. 20 °C), the value is usually around 70 % ($\pm 8 \%$) and on warm motors (operating temperature) around 100 % ($\pm 10 \%$). If there are any large differences, you can proceed on the assumption that the rated frequency P107 or the rated speed P108 do not correspond to the real values.
- ◆ If the rated motor frequency (engineered) is below 8 Hz, you have to set $P107 = 8.0\text{Hz}$ in the drive setting. The rated motor voltage P101 and the rated motor speed P108 have to be calculated in the ratio of $8 \text{ Hz} / f_{\text{Mot,N}}$.

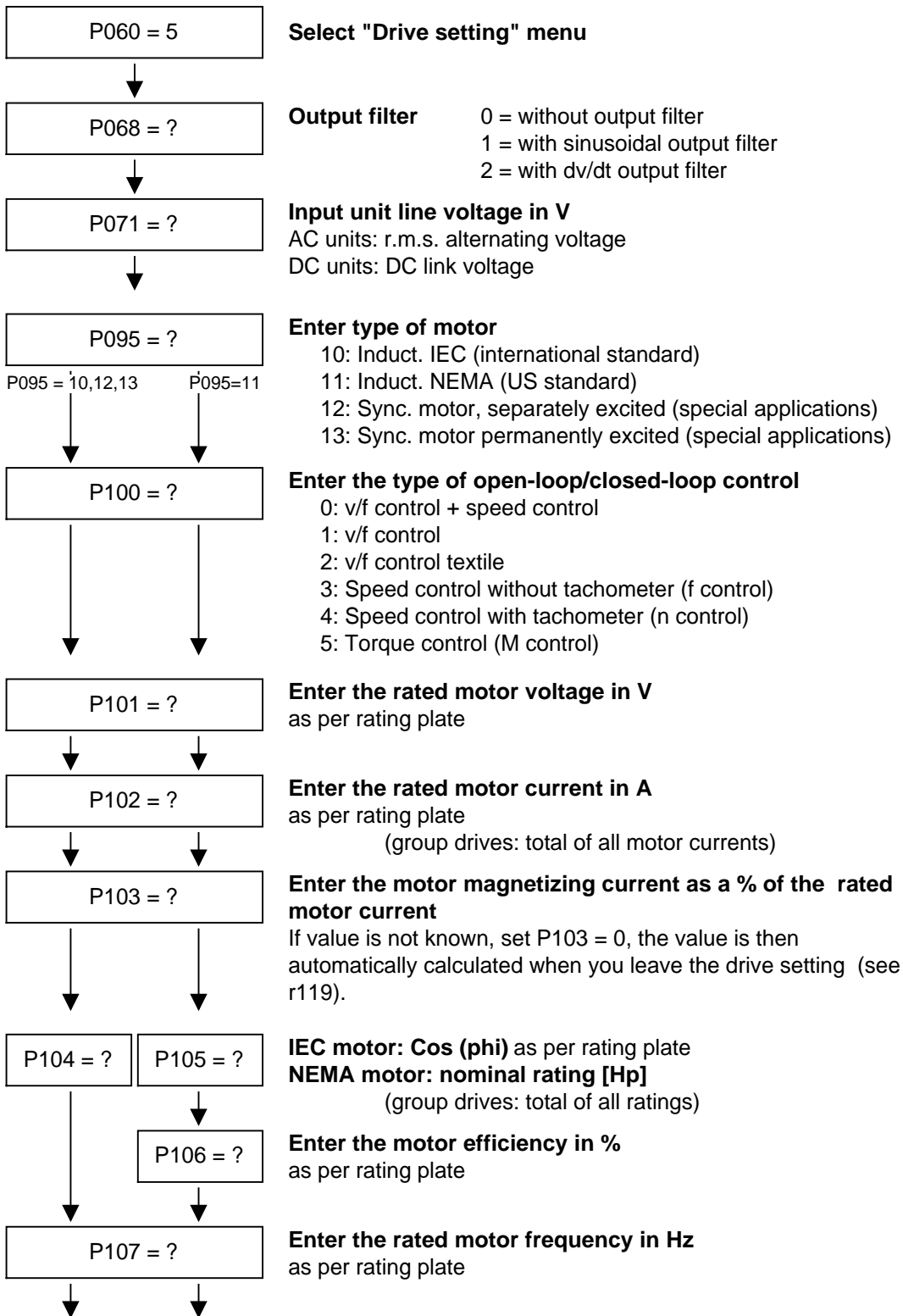

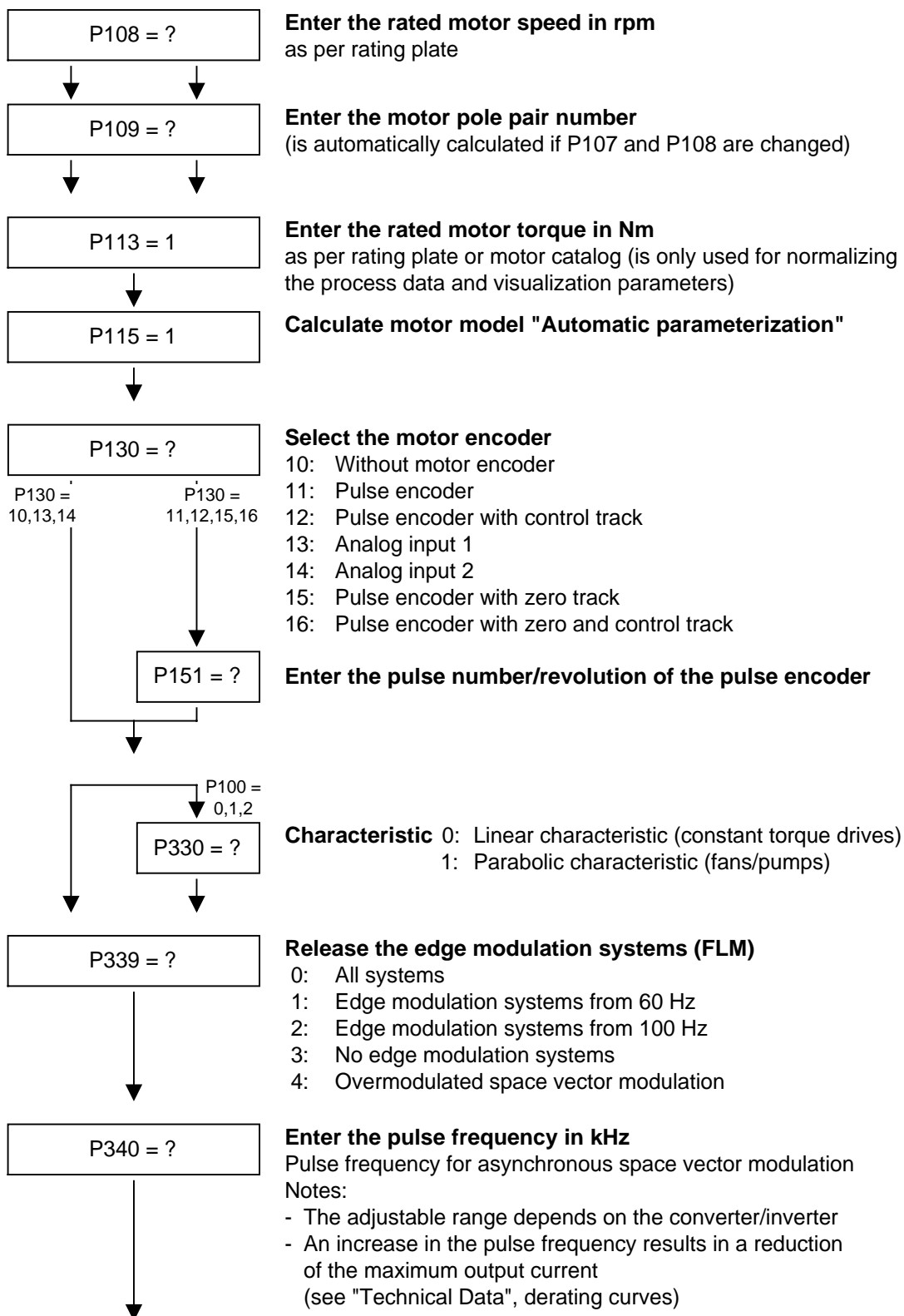

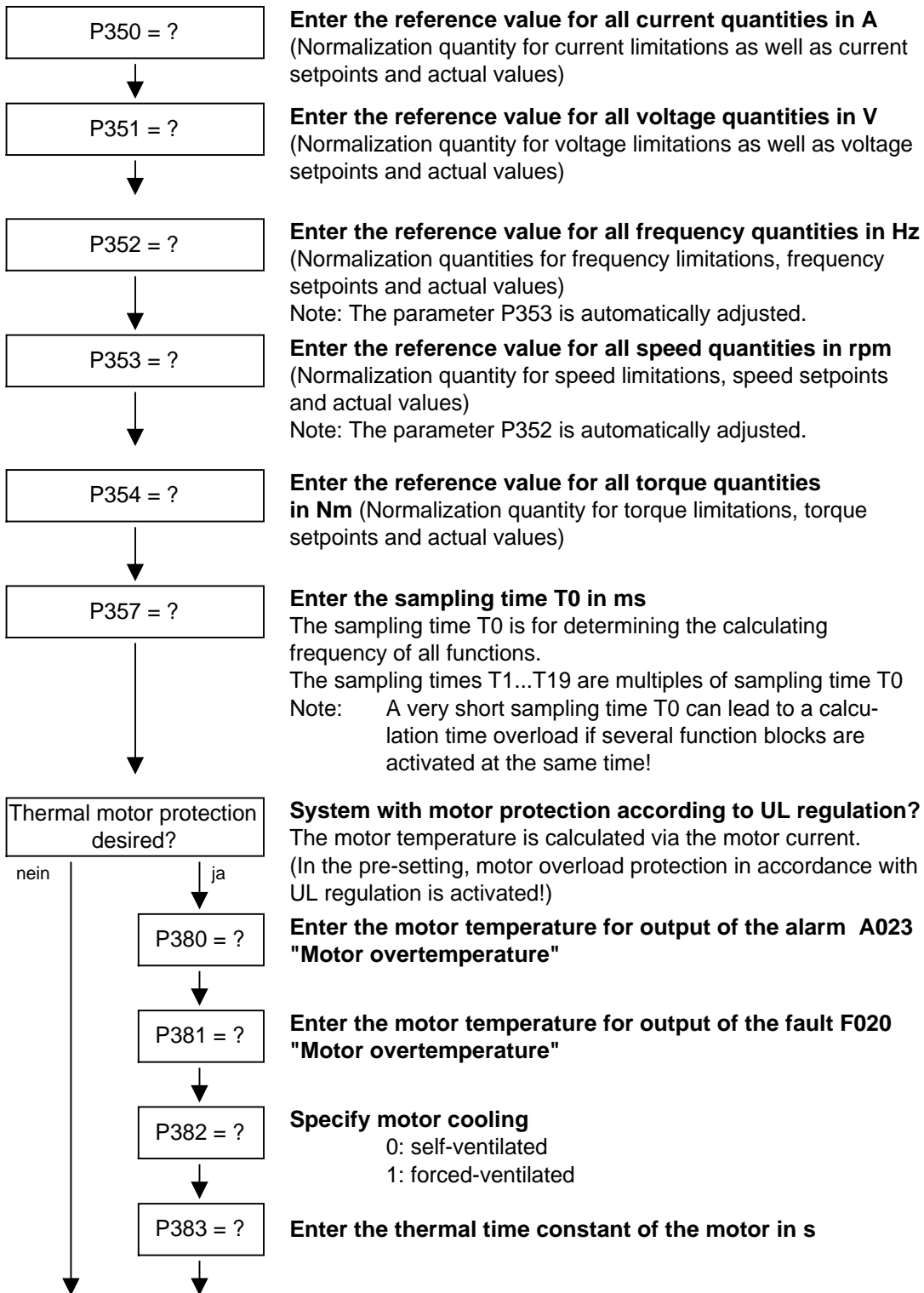

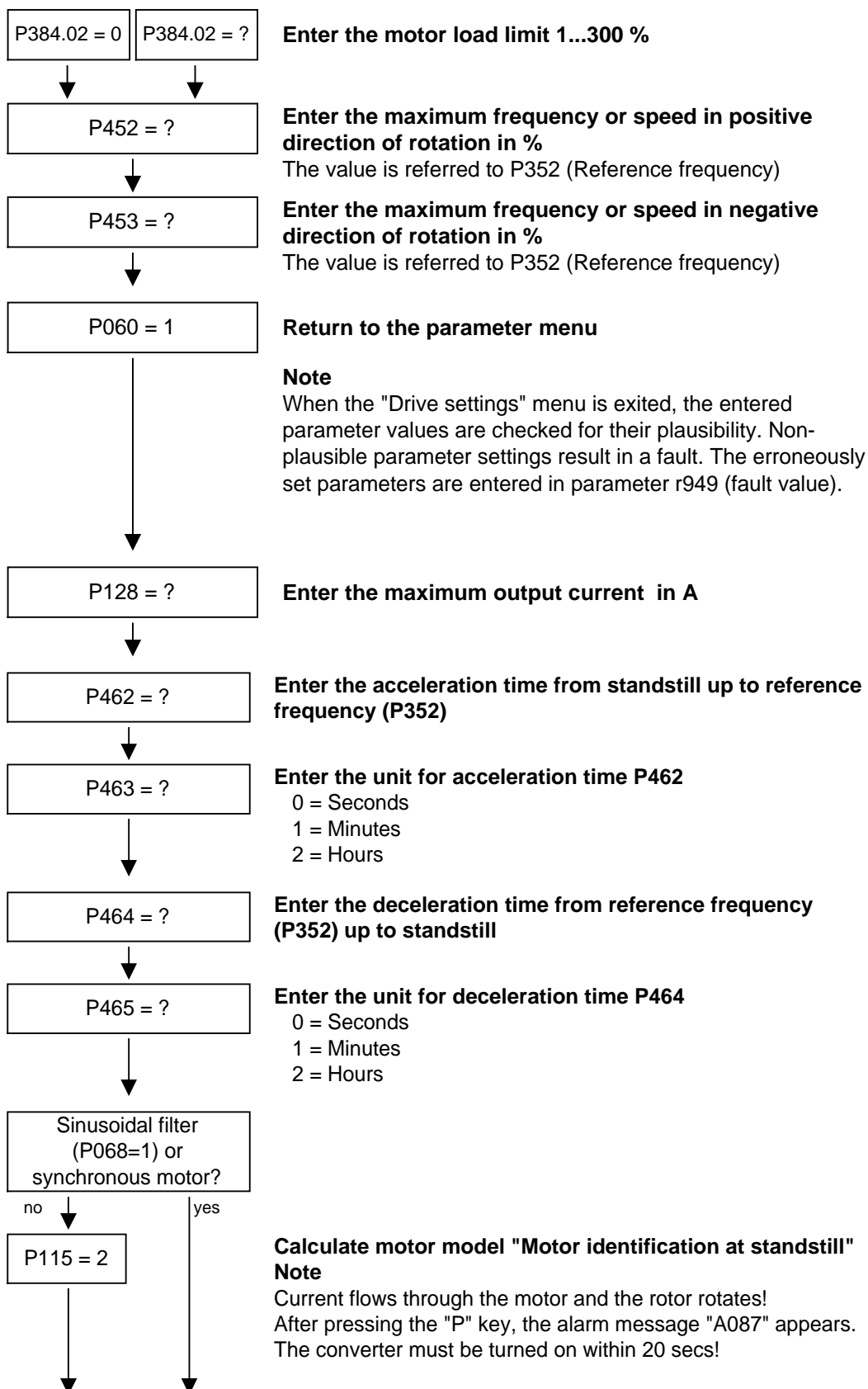

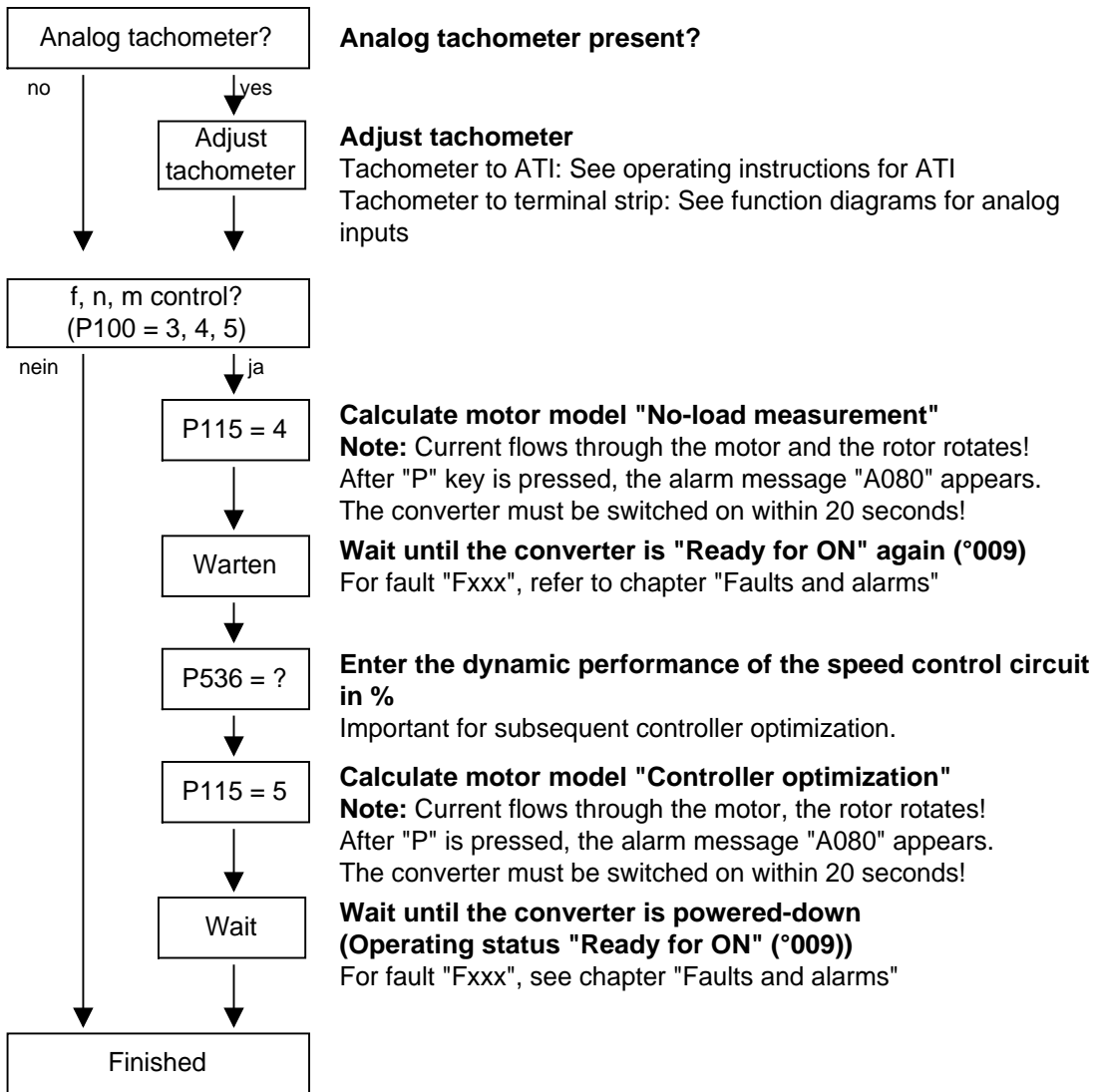

4.2.4 Start-up functions

The parameter list covers the setting parameters and visualization parameters of all available motor types (induction motors and synchronous motors), as well as all possible open-loop and closed-loop control modes (e.g. V/f characteristic, speed control).

The constellation under which this parameter is influenced or whether it is displayed at all is indicated under "Preconditions" in the parameter description.

Unless otherwise specified, all percentage values refer to the reference quantities in P350 to P354.

If reference quantities are changed, this will also change the significance of the parameters with percentage normalization (e.g. P352 = Maximum frequency).

Function diagrams and start-up instructions for separately excited synchronous motors (with damping cage and excitation via sliprings) are available separately.

The following parameters are only effective for these synchronous motors:

P75 to P88; P155 to P168, P187, P258, P274, P297, P298, P301, P302, P306 to P312.

The following parameters are calculated or set to fixed values during automatic parameterization (P115 = 1):

P116	P236	P303	P337
P117	P240	P306	P347
P120	P258	P313	P349
P121	P259	P315	P388
P122	P273	P316	P392
P127	P274	P319	P396
P128	P278	P322	P471
P161	P279	P325	P525
P215	P283	P326	P602
P216	P284	P334	P603
P223	P293	P335	
P235	P295	P336	

- ◆ P350 to P354 are only set to the rated motor quantities in the converter status "Drive setting".
- ◆ Automatic parameterization is also carried out by the standstill measurement P115 = 2, 3.
- ◆ During the standstill measurement P115 = 2, 3, the following parameters are measured or calculated:
 - P103, P120, P121, P122, P127, P347, P349.
The controller settings resulting from these values are in: P283, P284, P315, P316.
- ◆ During the rotating measurement P115 = 3, 4, P103 and P120 are adjusted.
- ◆ During the n/f controller optimization P115 = 5, the parameters P116, P223, P235, P236, P240 and P471 are determined.

4.3 Change to the parameter function selection (P052) VCal

The function selection parameter P052 of the firmware versions to the previous master drive VC units includes selecting the various special functions and start-up (commissioning) steps. In order to make this important parameter more transparent, the "special functions" and "start-up steps" function groups have been saved in the CUVC firmware in two different parameters.

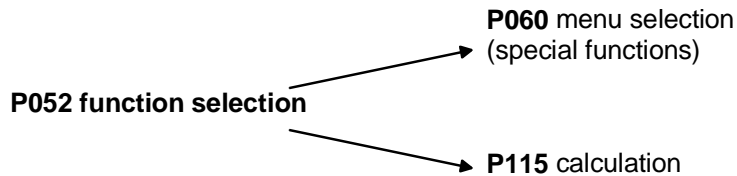

Fig. 4-2 Motor model (drive setting)

Further, the new special "user parameter" function has been introduced and the special "drive setting" function (P052=5) has been sub-divided into the "fast parameterization" and "drive setting" functions. The parameterization for the standard application is "hidden" behind the new special "fast parameterization" function, and behind the new "drive setting", the parameterization for the expert application.

The special "download/upread" function (P052=3) has been sub-divided into the "download" and "upread" functions.

P60	Menu selection	P052 (old)	Function selection
0=	User parameter	--	Refer to parameter list P060
1=	Parameter menu	0=	Return
2=	Fixed settings ¹⁾	1=	Par. reset
3=	Fast parameterization	5=	Drive setting
4=	Module configuration	4=	HW config.
5=	Drive setting	5=	Drive setting
6=	Download	3=	Download
7=	Upread	3=	Download
8=	Power module definition	2=	Order No. (MLFB) input

1) Selecting the factory setting menu (P366 factory setting type, activated with P970)











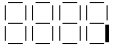
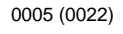

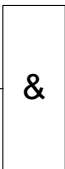
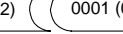
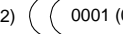
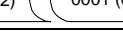
P115	Calculation, motor model	P052 (old)	Function selection
1=	Automatic parameterization	6=	AutomParam
2=	Motor identification at standstill	7=	MotidStill
3=	Complete motor identification	8=	MotidVollst
4=	No-load measurement	9=	LeerImess
5=	Speed/frequency controller optimization	10=	Regleropt
6=	Self-test	11=	Selbsttest
7=	Tachometer test	12=	Tachotest

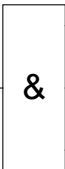
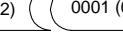
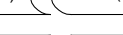
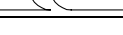
The new special function P060 = 0 (user parameter) allows the user to generate an important list of parameters for his particular application. After selecting P060 = 0 (user parameter), in addition to parameters P053, P060 and P358 only those parameters are visible, whose numbers have been entered in indices 4 to 100 of parameter P360.

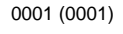
5 Process data

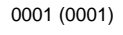
5.1 Control word 1 (visualization parameter r550 or r967)

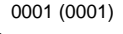
The factory setting is only valid for P366 = 0.

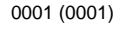
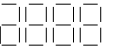
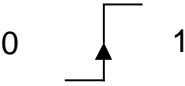
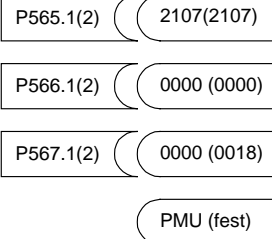
Designation Bit-No. (significance)	High / low values (1 = high, 0 = low)		Parameter No. BICO1 / BICO2	Factory setting BICO1 (BICO2) P366 = 0
	On	OFF1		
ON / OFF (stop) 0 	1	0	P554.1(2)	
OFF2 (electrical) 1 	No OFF2	OFF2	 <ul style="list-style-type: none"> P555.1(2)  P556.1(2)  P557.1(2)  	
OFF3 (fast stop) 2 	No OFF3	OFF3	 <ul style="list-style-type: none"> P558.1(2)  P559.1(2)  P560.1(2)  	
Inverter enable 3 	Free	Inhibited	P561.1(2)	
RFG enable 4 	Free	Inhibited	P562.1(2)	
RFG start 5 	Start	Stop	P563.1(2)	
Setpoint enable 6 	Free	Inhibited	P564.1(2)	
Acknowledge 7 	ON		P565.1(2) P566.1(2) P567.1(2)	

Designation Bit-No. (significance)	High / low values (1 = high, 0 = low)				Parameter No. BICO1 / BICO2	Factory setting BICO1 (BICO2) P366 = 0
Inching 1 / 2						
8					P568.1(2)	
9					P569.1(2)	
PZD control from the PLC	Control		No control			
10	1		0			
Enable rotating field	Both free	LDF	RDF	No DF		
11					P571.1(2)	
12					P572.1(2)	
Motorized potentiometer	Stop	Higher	Lower	Stop		
13	0	1	0	1	P573.1(2)	
14	0	0	1	1	P574.1(2)	
Fault, external 1	No fault		Fault, external 1			
15	1		0		P575.1(2)	

5.2 Control word 2 (visualization parameter r551)

The factory setting is only valid for P366 = 0.

Designation Bit-No. (significance)	High / low values (1 = high, 0 = low)				Parameter No. BICO1 / BICO2	Factory setting BICO1 (BICO2) P366 = 0
Function data set	FDS4	FDS3	FDS2	FDS1		
16	1	0	1	0	P576.1(2)	
17	1	1	0	0	P577.1(2)	
Motor data set	MDS4	MDS3	MDS2	MDS1		
18	1	0	1	0	P578.1(2)	
19		1	0	0	P579.1(2)	

Designation Bit-No. (significance)	High / low values (1 = high, 0 = low)				Parameter No. BICO1 / BICO2	Factory setting BICO1 (BICO2) P366 = 0
	4 / 8 / 12	3 / 7 / 11	2 / 6 / 10	1 / 5 / 9		
Fixed setpoint ¹⁾						
20	1	0	1	0	P580.1(2)	
21	1	1	0	0	P581.1(2)	
Synchronization	Synchr. enable		Synchr. inhibit			
22	1		0		P582.1(2)	
Restart-on-the-fly	Enable		Inhibited			
23	1		0		P583.1(2)	
Droop function enable	Enable		Inhibited			
24	1		0		P584.1(2)	
Controller enable	Enable		Inhibited			
25	1		0		P585.1(2)	
Fault, external 2	No fault		Fault, external 2			
26	1		0		P586.1(2)	
Slave/master drive	Slave drive (torque control)		Master drive (speed control)			
27	1		0		P587.1(2)	
Alarm, external 1	No alarm		Alarm, external 1			
28	1		0		P588.1(2)	
Alarm, external 2	No alarm		Alarm, external 2			
29	1		0		P589.1(2)	
BICO1 / BICO 2	BICO data set 1		BICO data set 2			
30	1		0		P590.1(2)	
Main contactor checkback signal	Main contactor checkback signal		No main contactor checkback signal			
31	1		0		P591.1(2)	

5.3 Description of the control word bits

The operating statuses can be read in visualization parameter r001: e.g. READY TO POWER-UP: r001 = 009

The function sequences are described in the sequence in which they are actually realized.

Bit 0: ON/OFF 1 command (↑ "ON") / (L "OFF1")

Condition	Positive edge change from L to H (L → H) in the READY TO POWER-UP condition (009).
Result	<ul style="list-style-type: none"> ◆ PRECHARGING (010) Main contactor (option)/bypass contactor, if available, are switched-in (closed). The DC link is pre-charged. ◆ READY (011) If the drive was last powered-down with "OFF2", the next condition is only selected after the de-energization time (P603) has expired since the last shutdown ◆ GROUND FAULT TEST (012), only when the ground fault test has been selected (P375). ◆ RESTART ON THE FLY (013), if restart on the fly (control word bit 23 via P583) has been enabled. ◆ RUN (014).
Condition	LOW signal and P100 = 3, 4 (closed-loop frequency/speed control)
Result	<ul style="list-style-type: none"> ◆ OFF1 (015), if the drive is in a status where the inverter is enabled. <ul style="list-style-type: none"> • For P100 = 3, 4 and slave drive, the system waits until the higher-level open-loop/closed-loop control shuts down the drive. • For P100 = 3, 4 and master drive, the setpoint at the ramp-function generator input is inhibited (setpoint = 0), so that the drive decelerates along the parameterized down ramp (P464) to the OFF shutdown frequency (P800). <p>After the OFF delay time (P801) has expired, the inverter pulses are inhibited, and the main contactor (option/bypass contactor), if available, are opened. If the OFF1 command is withdrawn again when the drive is ramping-down, (e.g. as the result of an ON command), ramp-down is interrupted, and the drive goes back into the RUN (014) condition.</p> ◆ For PRECHARGING (010), READY (011), RESTART-ON-THE-FLY (013) or MOT-ID-STANDSTILL (018), the inverter pulses are inhibited, and the main contactor (option)/bypass contactor, if available, is opened. ◆ POWER-UP INHIBIT (008) ◆ READY-TO-POWER-UP (009), if "OFF2" or "OFF3" are not present.
Condition	Low signal and P100 = 5 (closed-loop torque control)
Result	<ul style="list-style-type: none"> ◆ An OFF2 command (electrical) is executed.

Bit 1: OFF2 command (L "OFF2") electrical**Condition** LOW signal**Result**

- ◆ The inverter pulses are inhibited, and the main contactor (option)/bypass contactor, if available, are opened.
- ◆ POWER-ON INHIBIT (008), until the command is removed.

Note

The **OFF2** command is simultaneously connected from three sources (P555, P556 and P557)!

Bit 2: OFF3 command (L "OFF3") (fast stop)**Condition** LOW signal**Result**

- ◆ This command has two possible effects:
 - DC braking is enabled (P395 = 1):
DC BRAKING (017)
The drive decelerates along the parameterized downramp for OFF3 (P466) until the frequency for the start of DC braking is reached (P398).
The inverter pulses are then inhibited for the duration of the de-energization time (P603).
After this, the drive DC brakes with an adjustable braking current (P393) for a braking time which can be parameterized (P397).
The inverter pulses are then inhibited and the main contactor (option)/bypass contactor, if available, is opened.
 - DC braking is not enabled (P395 = 0):
The setpoint is inhibited at the ramp-function generator input (setpoint=0), so that the drive decelerates along the parameterized downramp for OFF3 (P466) to the OFF shutdown frequency (P800).
The inverter pulses are inhibited after the OFF delay time (P801) has expired, and the main/bypass contactor, if used, is opened. If the OFF3 command is withdrawn while the drive is decelerating, the drive still continues to accelerate.
- ◆ For PRE-CHARGING (010), READY (011), RESTART-ON-THE-FLY (013) or MOT-ID STANDSTILL (018), the inverter pulses are inhibited, and the main/bypass contactor, if used, is opened.
- ◆ If the drive operates as slave drive, when an OFF3 command is issued, it automatically switches-over to the master drive.
- ◆ POWER-ON inhibit (008), until the command is withdrawn.

Note

The **OFF3** command is simultaneously effective from three sources (P558, P559 and P560)!

Priority of the **OFF** commands: **OFF2 > OFF3 > OFF1**

Bit 3: Inverter enable command (H "inverter enable")/(L "inverter inhibit")

Condition	HIGH signal, READY (011) and the de-energization time (P603) has expired since the last time that the drive was shutdown.
Result	<ul style="list-style-type: none">◆ RUN (014) The inverter pulses are enabled and the setpoint is approached via the ramp-function generator.
Condition	LOW signal
Result	<ul style="list-style-type: none">◆ For RESTART-ON-THE-FLY (013), RUN (014), KINETIC BUFFERING with pulse enable, OPTIMIZATION OF THE SPEED CONTROLLER CIRCUIT (019) or SYNCHRONIZATION (020):◆ The drive changes over into the READY (011), condition, and the inverter pulses are inhibited.◆ If OFF1 is active (015), the inverter pulses are inhibited, the main/bypass contactor, if used, is opened, and the drive goes into the POWER-ON INHIBIT (008) condition.◆ If OFF3 is active (016 / fast stop), the inverter inhibit command is ignored, fast stop is continued and, after shutdown (P800, P801), the inverter pulses are inhibited.

Bit 4: Ramp-function generator inhibit command (L "RFG inhibit")

Condition	LOW signal in the RUN (014) condition.
Result	<ul style="list-style-type: none">◆ The ramp-function generator output is set to setpoint = 0.

Bit 5: Ramp-function generator hold command (L "RFG hold")

Condition	LOW signal in the RUN (014) condition.
Result	<ul style="list-style-type: none">◆ The actual setpoint is "frozen at the ramp-function generator output".

Bit 6: Setpoint enable command (H "setpoint enable")

Condition	HIGH signal and the de-energization time have expired (P602).
Result	<ul style="list-style-type: none">◆ The setpoint at the ramp-function generator input is enabled.

Bit 7: Acknowledge command (↑ "Acknowledge")

Condition	Rising (positive) edge change from L to H (L → H) in the FAULT condition (007).
Result	<ul style="list-style-type: none"> ◆ All of the current faults are deleted after they have been previously transferred into the diagnostics memory. ◆ POWER-ON INHIBIT (008), if no actual faults are present. ◆ FAULT (007), if there are no faults.

NOTE The **Acknowledge** command is simultaneously effective from the three sources (P565, P566 and P567) and always from the PMU!

Bit 8: Inching 1 ON command (↑ "Inching 1 ON") / (L "Inching 1 OFF")

Condition	Positive (rising) edge change from L to H (L → H) in the READY TO POWER-UP (009) condition.
Result	<ul style="list-style-type: none"> ◆ An ON command is automatically executed (refer to control word bit 0), and inching frequency 1 (P448) is enabled in the setpoint channel. <p>The ON/OFF1 command (bit 0) is ignored for active inching operation! The system must wait until the de-energization time (P603) has expired</p>
Condition	LOW signal
Result	<ul style="list-style-type: none"> ◆ An OFF1 command is automatically executed (refer to control word bit 0).

Bit 9: Inching 2 ON command (↑ "Inching 2 ON") / (L "Inching 2 OFF")

Condition	Rising (positive) edge change from L to H (L → H) in the READY TO POWER-UP (009) condition.
Result	<ul style="list-style-type: none"> ◆ An ON command is automatically executed (refer to control board bit 0), and inching frequency 2 (P449) is enabled in the setpoint channel. <p>The ON/OFF1 command (bit 0) is ignored if inching is active. The system must wait until the de-energization time (P603) has expired.</p>
Condition	LOW signal
Result	<ul style="list-style-type: none"> ◆ An OFF1 command is automatically executed (refer to control word bit 0).

Bit 10: Control from the PLC command (H "control from the PLC")

Condition	HIGH signal; the process data PZD (control word, setpoints) are only evaluated if the command has been accepted; this data is sent via the SST1 interface of the CU, the CB/TB interface (option) and the SST/SCB interface (option).
Result	<ul style="list-style-type: none"> ◆ If several interfaces are used, only the process data of the interfaces are evaluated, which send an H signal. ◆ For an L signal, the last values are received in the appropriate dual port RAM of the interface.

NOTE An H signal appears in the visualization parameter r550 "control word 1", if **one** of the interfaces sends an H signal!

Bit 11: Clockwise rotating field command (H "clockwise rotating field")

Condition	HIGH signal
Result	<ul style="list-style-type: none"> ◆ The setpoint is influenced in conjunction with bit 12 "counter-clockwise rotating field".

Refer to the function diagram "Setpoint channel", Part 1 (316)

Bit 12: Counter-clockwise rotating field command (H "counter-clockwise rotating field")

Condition	HIGH signal
Result	<ul style="list-style-type: none"> ◆ The setpoint is influenced in conjunction with bit 11 "clockwise-rotating field".

Refer to the function diagram, "Setpoint channel", Part 1 (316)

NOTE The **counter-clockwise rotating field** and the **clockwise rotating field** command have no influence on supplementary setpoint 2, which is added after the ramp-function generator (RFG)!

Bit 13: Command to raise the motorized potentiometer (H "raise motorized potentiometer")

Condition	HIGH signal
Result	<ul style="list-style-type: none"> ◆ The motorized potentiometer in the setpoint channel is driven in conjunction with bit 14 "motorized potentiometer, lower".

Refer to the function diagram "Setpoint channel" (300)

Bit 14: Command to lower the motorized potentiometer (H "lower motorized potentiometer")

Condition	HIGH signal
Result	<ul style="list-style-type: none"> ◆ The motorized potentiometer in the setpoint channel is driven in conjunction with bit 13 "raisemotorized potentiometer".

Refer to the function diagram "Setpoint channel" (300)

Bit 15: Command external fault 1 (L "External fault 1")**Condition** LOW signal**Result** ♦ FAULT (007) and fault message (F035).
The inverter pulses are inhibited, the main contactor/bypass contactor, if used, is opened.*Refer to the section "Fault- and alarm messages"***Bit 16: Function data set FDS bit 0 command****Result** ♦ In conjunction with bit 17 "FDS BIT 1" one of the four possible function data sets is energized.**Bit 17: Function data set FDS bit 1 command****Result** ♦ In conjunction with bit 16 "FDS BIT 0" one of the four possible function data sets is energized.**Bit 18: Motor data set, MDS bit 0 command****Condition** READY TO POWER-UP (009), PRE-CHARGING (010) or READY (011)**Result** ♦ One of the four possible motor data sets is energized in conjunction with bit 19 "MDS BIT 1".**Bit 19: Motor data set, MDS bit 1 command****Condition** READY TO POWER-UP (009), PRE-CHARGING (010) or READY (011)**Result** ♦ One of the four possible motor data sets is energized in conjunction with bit 18 "MDS BIT 0".**Bit 20: Fixed setpoint FSW bit 0 (LSB) command****Result** ♦ In conjunction with bit 21 "FSW BIT 1", one of the four possible fixed setpoints is energized to input as percentage fixed setpoints, referred to the reference frequency P352 or reference speed P353.*Refer to the function diagram "Fixed setpoints" (290), also refer to FSW bit 2 and bit 3, parameter P417, P418*

Bit 21: Fixed setpoint FSW bit 1 (MSB) command

- Result**
- ◆ In conjunction with bit 20 "FSW BIT 0" one of the four possible fixed setpoints is energized for input as percentage fixed setpoints, referred to the reference frequency P352 or the reference speed P353.

Refer to the function diagram "Fixed setpoints" (290), also refer to FSW bit 2 and bit 3, parameters P417, P418

Bit 22: Synchronizing enable command (H "synchronizing enable")

- Condition** HIGH signal, TSY (option) available and P100 = 2 (V/f characteristic for textile applications).
- Result**
- ◆ The command enables the synchronizing function.

Bit 23: Restart-on-the-fly enable command (H "restart-on-the-fly enable")

- Condition** HIGH signal
- Result**
- ◆ The command enables the restart-on-the-fly function.

Bit 24: Droop/technology controller enable command (H "droop/technology controller enable")

- Condition** HIGH signal
- Result**
- ◆ The command enables the droop function, if P100 (open-loop/closed-loop control type) is assigned 3 (closed-loop frequency control) or 4 (closed-loop speed control), parameter P246 <> 0 and the inverted pulses of the drive converter are enabled. The speed/frequency controller output, fed back as negative signal to the speed/frequency setpoint, can be set via parameter P245 (droop) and P246 (droop Kp)

Refer to function diagrams 365 and 362

Bit 25: Controller enable command (H "controller enable")

- Condition** HIGH signal and the drive converter inverter pulses are enabled.
- Result**
- ◆ The speed controller output is enabled for the appropriate control type (P100 = 0,4,5).

Refer to function diagrams 360 and 361

Bit 26: Command, external fault 2 (L "External fault 2")

- Condition** LOW signal; it is only activated from the READY (011) condition onwards and after an additional time delay of 200 ms.
- Result**
- ◆ FAULT (007) and fault message (F036). The inverter pulses are inhibited, the main contactor, if available, is opened.

Bit 27: Slave/master drive command (H "Slave drive")/(L "Master drive")

Condition HIGH signal, P100 (open-loop/closed-loop control type) = 3, 4 (closed-loop frequency/speed control), and the drive inverter pulses are enabled.

Result ♦ Slave drive: The closed-loop control acts as closed-loop torque control (M closed-loop control).

Condition LOW signal, P100 (open-loop/closed-loop control type) = 3, 4 (closed-loop frequency/speed control), and the drive converter inverter pulses are enabled.

Result ♦ Master drive: The closed-loop control operates as closed-loop speed or frequency control (closed-loop frequency/speed control).

Refer to the function diagrams 350, 351, 360, 361, 362, 363, 370, 371, 372, 373

Bit 28: Command, external alarm 1 (L "External alarm 1")

Condition LOW signal

Result ♦ The operating status is maintained. An alarm message is issued (A015).

Bit 29: Command, external alarm 2 (L "External alarm 2")

Condition LOW signal

Result ♦ The operating status is maintained. An alarm message is issued (A016).

Bit 30: Select, BICO data sets (H "data set 2") / (L "data set 1")

Condition HIGH signal

Result ♦ The parameter settings of data set 2 for all binector and connector commands and signals, are activated.

Condition LOW signal

Result ♦ The parameter settings of data set 1 for all binector and connector commands and signals, are activated.

Bit 31: Main contactor checkback signal command (H "main contactor checkback signal")

Condition HIGH signal, corresponding to the wiring and parameterization of the main contactor (option).

Result ♦ Checkback signal, "main contactor energized" (closed).

5.4 Status word 1 (visualization parameter r552 or r968)

Bit #	Value	1 = High	Selection	
		0 = Low	Binector	Binector, inverted
Bit 0	1	Ready to power-up	– B0100	
	0	Not ready to power-up		– B0101
Bit 1	1	Ready	– B0102	
	0	Not ready		– B0103
Bit 2	1	Run	– B0104	
	0	Inverter pulses inhibited		– B0105
Bit 3	1	Fault	– B0106	
	0	No fault		– B0107
Bit 4	1	No OFF2	– B0108	
	0	OFF2		– B0109
Bit 5	1	No OFF3	– B0110	
	0	OFF3		– B0111
Bit 6	1	Power-on inhibit	– B0112	
	0	No power-on inhibit		– B0113
Bit 7	1	Alarm	– B0114	
	0	No alarm		– B0115
Bit 8	1	No setpoint-actual value deviation	– B0116	
	0	Setpoint-actual value deviation		– B0117
Bit 9	1	PZD control requested	– B0118	
	0	(not permissible)		– B0119
Bit 10	1	Comparison frequency reached	– B0120	
	0	Actual value < comparison frequency		– B0121
Bit 11	1	Fault, undervoltage	– B0122	
	0	No fault, undervoltage		– B0123
Bit 12	1	Main contactor driven	– B0124	
	0	Main contactor not driven		– B0125
Bit 13	1	RFG active	– B0126	

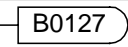
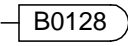
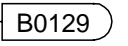
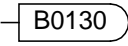
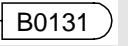
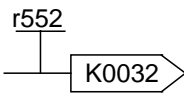

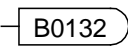
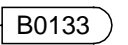
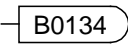
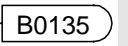
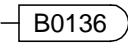
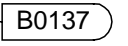
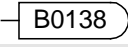
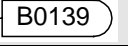
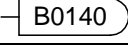
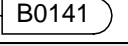
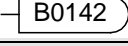
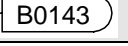
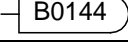
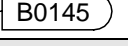
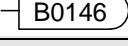
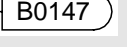

Bit #	Value	1 = High	Selection	
		0 = Low	Binector	Binector, inverted
	0	RFG not active		
Bit 14	1	Clockwise rotating field		
	0	Counter-clockwise rotating field		
Bit 15	1	KIP / FLN active		
	0	KIP / FLN not active		
		Status word 1 (bit 0 - 15)		

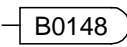
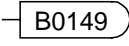
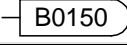
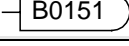
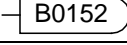
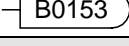
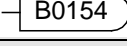
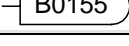
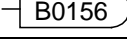
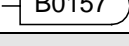
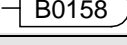
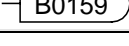
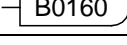
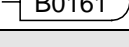
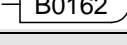
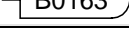
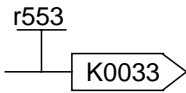
5.5 Status word 2 (visualization parameter r553)

Bit #	Value	1 = High	Selection	
		0 = Low	Binector	Binector inverted
Bit 16	1	Restart-on-the-fly or energization active		
	0	Restart-on-the-fly or energization not active		
Bit 17	1	Synchronism reached		
	0	Synchronism not reached		
Bit 18	1	No overspeed		
	0	Overspeed		
Bit 19	1	Fault, external 1		
	0	No fault, external 1		
Bit 20	1	Fault, external 2		
	0	No fault, external 2		
Bit 21	1	Alarm, external		
	0	No alarm, external		
Bit 22	1	Alarm, i2t converter		
	0	No alarm, i2t converter		
Bit 23	1	Fault, drive converter overtemperature		
	0	No fault, drive converter overtemperature		

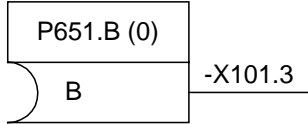
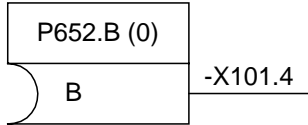
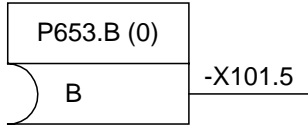
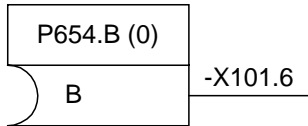
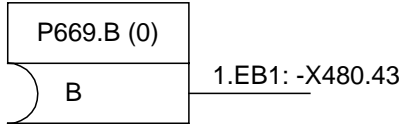
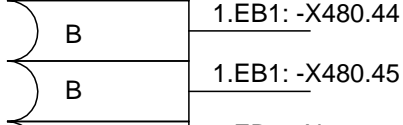
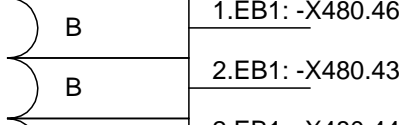
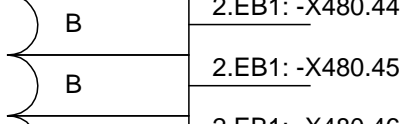
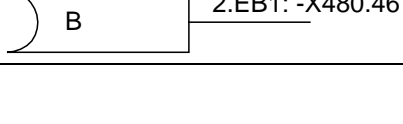
Bit #	Value	1 = High	Selection	
		0 = Low	Binector	Binector inverted
Bit 24	1	Alarm, drive converter overtemperature		
	0	No alarm, drive converter overtemperature		
Bit 25	1	Alarm, motor overtemperature		
	0	No alarm, motor overtemperature		
Bit 26	1	Fault, motor overtemperature		
	0	No fault, motor overtemperature		
Bit 27	1			
	0			
Bit 28	1	Fault, motor stalled/rotor blocked		
	0	No fault, motor stalled/rotor blocked		
Bit 29	1	Bypass contactor controlled		
	0	Bypass contactor not controlled		
Bit 30	1	Alarm, synchronizing error		
	0	No alarm, synchronizing error		
Bit 31	1	Pre-charging active		
	0	Pre-charging not active		
		Status word 2 (Bits 16 - 31)		

5.6 Possible targets for the wiring of the binectors of the status words

Digital outputs on the CUVC		
		<p>Note:</p> <p>For the terminals -X101.3-6 on the CUVC, it involves bi-directional digital inputs/outputs. When used as digital input, both indices of the destination (target) parameter (P651-P654) must be set to zero. If these terminals are used as digital outputs, both indices of the target (destination) parameter (P651-P654), may not be zero.</p> <p>If the second BICO data set is used, it is possible, to save different binectors in both indices .0 and .1 of parameter P651-654.</p> <p>If the second BICO data set is not used, the same binector is saved in both indices (0. and .1).</p>
		
		
		
Digital outputs EB1		
		<p>Note:</p> <p>For terminals X480.43-46, it involves bi-directional digital I/O. To use as digital input, the appropriate index of the parameter P669 must be set to '0'.</p> <p>It is possible to use a maximum of two EB1.</p> <p>P669 is a parameter to select binectors, whose value is to be output at terminals -X480.43...46.</p> <p>Index 1...4: DIO1...DIO4 of the first inserted EB1</p> <p>Index 5...8: DIO1...DIO4 of the second inserted EB1</p>
		
		
		
		
		
		
		

Digital outputs EB2		
<div style="border: 1px solid black; padding: 2px; margin-bottom: 2px;">P674.B (0)</div>		<p>Note:</p> <p>For the digital outputs of EB2, it involves floating (electrically isolated) relay outputs.</p> <p>P674 is a parameter to select the binectors, whose values are to be output at terminal strip -X490 of EB2.</p> <p>Index 1...4: DO1...DO4 of the first inserted EB2</p> <p>Index 5...8: DO1...DO4 of the second inserted EB2</p>
Main contactor control (terminal -X9)		
<div style="border: 1px solid black; padding: 2px; margin-bottom: 2px;">P601.B (270)</div>	<p>Note:</p> <p>This parameter is used to connect bit 12 of status word 1. The pre-assignment with binector B0270 fulfills the same function as binector B0124 assigned bit 12 of status word 1.</p>	

5.7 Description of the status word bits

Bit 0: Message, "Ready to power-up" (H)

HIGH signal	POWER-ON INHIBIT (008) or READY TO POWER-UP (009) status
Significance	<ul style="list-style-type: none"> ◆ The power supply, the open- and closed-loop control are operational. ◆ The inverter pulses are inhibited. ◆ If an external power supply and a main contactor (option)/bypass contactor are available, it is possible to bring the DC link into a no-voltage condition, when the drive converter is in this status!

Bit 1: Message, "Ready" (H)

HIGH signal	PRE-CHARGING (010) or READY (011) status
Significance	<ul style="list-style-type: none"> ◆ The power supply, the open-loop and the closed-loop control are operational. ◆ The unit is powered-up. ◆ Pre-charging has been completed. ◆ The DC link has been ramped-up to the full voltage. ◆ The inverter pulses are still inhibited.

Bit 2: Message, "Run" (H)

HIGH signal	RESTART-ON-THE-FLY (013), RUN (014), OFF1 (015) or OFF3 (016)
Significance	<ul style="list-style-type: none"> ◆ The unit is functioning. ◆ The inverter pulses are enabled. ◆ The output terminals are live.

Bit 3: Message "Fault" (H)

HIGH signal	Fault (007) status
Significance	<ul style="list-style-type: none"> ◆ A fault has occurred. <p><i>Output at the terminal strip (PEU, CUVC, TSY, SCI1/2, EB1, EB2) with L signal.</i></p>

Bit 4: Message "OFF2" (L)

LOW signal	OFF2 command available
Significance	<ul style="list-style-type: none"> ◆ The OFF2 command was output (control word bit 1).

Bit 5: Message "OFF3" (L)

LOW signal	OFF3 (016) status, and/or OFF3 command available
Significance	<ul style="list-style-type: none"> ◆ The OFF3 command was output (control word bit 2).

Bit 6: Message "Power-on inhibit" (H)

HIGH signal	POWER-ON INHIBIT (008) status
Significance	<ul style="list-style-type: none">◆ The power supply, open-loop and closed-loop control are operational.◆ If an external power supply and a main contactor (option)/bypass contactor are available, it is possible to bring the DC link voltage in this drive converter status into a no-voltage condition!◆ The message is available as long as an OFF2 command is present via control word bit 1 or an OFF3 command is available via control word bit 2 after the setpoint has been ramped-down, or an ON command is available via control word bit 0 (edge evaluation).

Output at the terminal strip (PEU, CUVC, TSY, SC11/2, EB1, EB2) with L signal.

Bit 7: Message, "Alarm" (H)

HIGH signal	Alarm (Axxx)
Significance	<ul style="list-style-type: none">◆ An alarm has been issued.◆ The signal is present until the cause has been resolved.

Output at the terminal strip (PEU, CUVC, TSY, SC11/2, EB1, EB2) with L signal.

Bit 8: Message "Setpoint-actual value deviation" (L)

LOW signal	Alarm, "Setpoint-actual value deviation" (A034)
Significance	<ul style="list-style-type: none">◆ The frequency actual value deviates from the frequency setpoint (reference value, by a value which exceeds P794 (setpoint-actual value deviation, frequency), for a time which is longer than P792 (setpoint-actual value deviation time).◆ The bit is again set as H signal, if the deviation is less than parameter value P792.

Bit 9: Message "PZD control requested" (H)

HIGH signal	Still present.
--------------------	----------------

Bit 10: Message, "Comparison frequency reached" (H)

HIGH signal	The parameterized comparison frequency has been reached.
Significance	<ul style="list-style-type: none">◆ The absolute frequency actual value is greater than or equal to the parameterized comparison frequency (P796).◆ The bit is again set to L signal, as soon as the absolute value of the comparison frequency (P796), minus the parameterized comparison frequency hysteresis (P797 as %, referred to the comparison frequency (P796)) is fallen below.

Bit 11: Message "Fault, undervoltage" (H)

HIGH signal	"Undervoltage in the DC link" fault (F008)
Significance	<ul style="list-style-type: none"> ◆ The DC link voltage has fallen below the permissible limit value. Refer to the Section "Fault- and alarm messages" <p><i>Output at the terminal strip (PEU, CUVC, TSY, SCI1/2, EB1, EB2) with L signal.</i></p>

Bit 12: Message "Main contactor energized" (H)

HIGH signal	The main contactor/bypass contactor (option) is energized.
Significance	<ul style="list-style-type: none"> ◆ The main contactor/bypass contactor (option) can be driven with the appropriate wiring and parameterization.

Bit 13: Message "RFG active" (H)

HIGH signal	Ramp-function generator active
Significance	<ul style="list-style-type: none"> ◆ The ramp-function generator output (r480 / KK0073) is not equal to the ramp-function generator input (r460 / KK0072). A hysteresis, which can be parameterized (P476 as %, referred to the rated system frequency P352), can only be taken into account for an analog setpoint input. ◆ When the "synchronizing" function is selected, alarm A069 is initiated, as long as the ramp-function generator is active in the setpoint channel of the synchronizing converter. The synchronizing operation is not started as long as the ramp-function generator is active.

Bit 14: Message, "Clockwise rotating field" (H)/"Counter-clockwise rotating field" (L)

HIGH signal	Clockwise rotating field
Significance	<ul style="list-style-type: none"> ◆ The frequency setpoint for the closed-loop control (speed/frequency setpoint, r482 / KK0075) is greater than or equal to 0.
LOW signal	Counter-clockwise rotating field
Significance	<ul style="list-style-type: none"> ◆ The frequency setpoint for the closed-loop control (speed/frequency setpoint, r482 / KK0075) is less than 0.

Bit 15: Message "KIP/FLN active" (H)

HIGH signal	The kinetic buffering (KIP) function or flexible response (FLN) is active.
Significance	<ul style="list-style-type: none"> ◆ KIP: A brief power failure is bypassed using the kinetic energy of the connected load.. ◆ FLN: The converter can be operated up to a minimum DC link voltage of 50% of the rated value.

Bit 16: Message "Restart-on-the-fly active" (H)

HIGH signal	The restart-on-the-fly function is active, or the de-energization time (P602) is running.
Significance	<ul style="list-style-type: none"> ◆ The drive converter is switched to a motor which is still rotating. ◆ Overcurrent is prevented as a result of the restart-on-the-fly function. ◆ The excitation time (magnetization time) is active.

Bit 17: Message "Synchronism has been reached" (H)

HIGH signal	Synchronism has been reached.
Significance	◆ Synchronism has been reached.
Prerequisite	TSY (option) available and P100 (open-loop/closed-loop control type) = 2 (V/f characteristic for textile applications).

Bit 18: Message "Overspeed" (L)

LOW signal	Alarm "Overspeed" (A033)
Significance	<ul style="list-style-type: none"> ◆ The frequency actual value is either: <ul style="list-style-type: none"> ◆ greater than the maximum frequency for the clockwise rotating field (P452) plus a hysteresis (P804 as %, referred to P452) or ◆ less than the maximum frequency for the counter-clockwise rotating field (P453) plus a hysteresis (P804 as %, referred to P453). ◆ The bit is again set to an H signal as soon as the absolute value of the frequency actual value is less than or equal to the absolute value of the appropriate maximum frequency.

Bit 19: Message "External fault 1" (H)

HIGH signal	"External fault 1"
Significance	<ul style="list-style-type: none"> ◆ A "External fault 1" is present in control word, bit 15. <p><i>Output at the terminal strip (PEU, CUVC, TSY, SC11/2, EB1, EB2) with L signal.</i></p>

Bit 20: Message "External fault 2" (H)

HIGH signal	"External fault 2"
Significance	<ul style="list-style-type: none"> ◆ A "External fault 2" is present in control word bit 26. <p><i>Output at the terminal strip (PEU, CUVC, TSY, SC11/2, EB1, EB2) with L signal.</i></p>

Bit 21: Message "External alarm" (H)

HIGH signal	"External alarm"
Significance	<ul style="list-style-type: none"> ◆ An "external alarm 1" is present in control word bit 28, or, "external alarm 2" in control word bit 29. <p><i>Output at the terminal strip (PEU, CUVC, TSY, SC11/2, EB1, EB2) with L signal.</i></p>

Bit 22: Message "Alarm i²t drive converter" (H)**HIGH signal** Alarm "i²t alarm, inverter" (A025)**Significance** ♦ If the instantaneous load status is maintained, then the drive converter will be thermally overloaded.*Output at the terminal strip (PEU, CUVC, TSY, SC11/2, EB1, EB2) with L signal.***Bit 23: Message "Fault, converter overtemperature" (H)****HIGH signal** "Inverter temperature too high" fault (F023)**Significance** ♦ The limiting inverter temperature has been exceeded.*Output at the terminal strip (PEU, CUVC, TSY, SC11/2, EB1, EB2) with L signal.***Bit 24: Message "Alarm, converter overtemperature" (H)****HIGH signal** Alarm, "inverter temperature too high" (A022)**Significance** ♦ The inverter temperature threshold to release an alarm has been exceeded.*Output at the terminal strip (PEU, CUVC, TSY, SC11/2, EB1, EB2) with L signal.***Bit 25: Message "Alarm, motor overtemperature" (H)****HIGH signal** Alarm "Motor overtemperature"**Significance** ♦ it involves an "I²t alarm, motor" (A029) or an overtemperature alarm from the KTY (P380 > 0).
♦ The alarm is initiated either by calculating the motor load (r008 / K0244) or from the KTY84 sensor (r009 / K0245).
♦ Parameters involved in the calculation:
P380 (mot. temp. alarm), P382 (motor cooling),
P383 (mot. temp.T1), P384 (mot. load limit).*Output at the terminal strip (PEU, CUVC, TSY, SC11/2, EB1, EB2) with L signal.***Bit 26: Message "Fault, motor overtemperature" (H)****HIGH signal** Fault, "Motor overtemperature"**Significance** ♦ It involves an "I²t fault, motor" (F021) or an overtemperature fault, from KTY (P381 > 1) or PTC thermistor (P381 = 1).*Output at the terminal strip (PEU, CUVC, TSY, SC11/2, EB1, EB2) with L signal.***Bit 27: Reserve**

Bit 28: Message "Fault, motor stalled/locked" (H)

HIGH signal Fault, "Motor stalled or blocked" (F015)

Significance ♦ The drive has either stalled or is locked.

Output at the terminal strip (PEU, CUVC, TSY, SC11/2, EB1, EB2) with L signal.

Bit 29: Message "Bypass contactor energized" (H)

HIGH signal The bypass- (pre-charging) contactor is energized. (Only for AC units)

Significance ♦ A bypass contactor (option) can be energized with the appropriate wiring and parameterization.

Bit 30: Message "Alarm sync. error" (H)

HIGH signal Alarm, "Synchronizing error" (A070)

Significance ♦ After successful synchronization, the phase deviation is greater than the parameterized tolerance range (P531).

Prerequisite TSY (option) available and P100 (open-loop/closed-loop control type) = 2 (V/f characteristic for textile applications).

Output at the terminal strip (PEU, CUVC, TSY, SC11/2, EB1, EB2) with L signal.

Bit 31: Message "Pre-charging active" (H)

HIGH signal PRE-CHARGING (010) condition

Significance ♦ Pre-charging is realized after an ON command.

5.8 Setpoint wiring

An individual source can be parameterized for each setpoint (fixed values, analog inputs, PZD parts of the part program for the automation devices)

The selection parameters for the sources of the setpoints are BICO parameters. These parameters are indexed twice.

- ◆ Index i001: BICO data set 1
- ◆ Index i001: BICO data set 2

5.8.1 Important setpoints

		Gain	Normalization	Visualization
Speed controller gain adaptation	P231	-	-	r237
Supplementary setpoint 1	P433	P434	4000Hex = P352	r437
Supplementary setpoint 2	P438	P439	4000Hex = P352	r442
Main setpoint	P443	P444	4000Hex = P352	r447
Torque setpoint	P486	P487	4000Hex = P354	r490
Upper torque limiting	P493	P494	4000Hex = P354	r496
Lower torque limiting	P499	P500	4000Hex = P354	r502
Torque/current supplementary value	P506	P507	4000Hex = P354	r510
Initial angle	P172	-	-	r185, r186

Table 5-1 Interdependencies of the parameters for gain, normalization and visualization

The sources are selected from the connector list.

5.8.2 Important setpoint sources

5.8.2.1 Interfaces

Setpoints from SST 1	(16-bit)	Word	K2001-K2016
	(32-bit)	D word	KK2031-KK2045
Setpoints from CB/TB	(16-bit)	Word	K3001-K3016
	(32-bit)	D word	KK3031-KK3045
Setpoints from SST 2	(16-bit)	Word	K6001-K6016
	(32-bit)	D word	KK6031-KK6045
Setpoints from SLB	(16-bit)	Word	K7001-K7016
	(32-bit)	D word	KK7031-KK7045
Setpoints from 2.CB	(16-bit)	Word	K8001-K8016
	(32-bit)	D word	KK8031-KK8045

5.8.2.2 Analog inputs AI

CUVC	AI 1	K0011	Configuration: P631-P636,r637
	AI 2	K0013	
1.EB1	AI 1	K5101	Configuration: P655-P661, r662
	AI 2	K5102	
	AI 3	K5103	
1.EB2	AI	K5111	Configuration: P675-P681, r682
2.EB1	AI 1	K5201	Configuration: P655-P661, r662
	AI 2	K5202	
	AI 3	K5203	
2.EB2	AI	K5211	Configuration: P675-P681, r682
SCISI.1	AI 1	K4101	Configuration P690-P692
	AI 2	K4102	
	AI 3	K4102	
	AI 3	K4103	
SCISI.2	AI 1	K4201	Configuration P690-P692
	AI 2	K4202	
	AI 3	K4203	

5.8.2.3 Fixed setpoints FSW

Fixed connector	0	K0000
Fixed connector	100 %	K0001
Fixed connector	200 %	K0002
Fixed connector	-200 %	K0004
Fixed connector	-50 %	K0005
Fixed connector	-150 %	K0008
Actual FSW		KK0040
FSW 1-12		KK0041-KK0052
T limit 1 FSW		K0170
T limit 2 FSW		K0171
T suppl. FSW		K0087
I suppl. FSW		K0088

5.9 Actual value wiring

Each actual value destination (analog outputs, PZD part of the telegram from the automation devices), can be individually assigned an actual value by parameterizing the appropriate source parameters (destination).

The selection parameters can be indexed several times. The significance of the indices is parameter-specific (e.g. number of analog outputs of a particular board, number of the word of a telegram from automation devices).

Important source parameters for actual values (destinations)

5.9.1 Analog outputs AO

S. CUVC	AO1	P640.1	Configuration: P640 - P644
	AO2	P640.2	
S. 1.EB1	AO1	P663.1	Configuration: P663 - P667,r668
	AO2	P663.2	
S. 2.EB1	AO1	P663.3	
	AO2	P663.4	
S. 1.EB2	AO	P683.1	Configuration: P683 - P687.r688
S. 2.EB2	AO	P683.2	
S.SCI-SL1	AO1	P693.1	Configuration: P693 - P695
	AO2	P693.2	
	AO3	P693.3	
S.SCI-SL2	AO1	P693.4	
	AO2	P693.5	
	AO3	P693.6	

5.9.2 Interfaces

S. SCB	Send data	P706.1-16
S. SST1	Send data	P707.1-16
S. SST2	Send data	P708.1-16
S. CB/TB	Send data	P734.1-16
S. 2.CB	Send data	P736.1-16
S. SLB	Send data	P751.1-16

5.9.3 General

KK0020	Speed, smoothed		r015
K0021	Output voltage		r003
K0022	Output current		r004
K0023	Output power		r005
K0024	Torque		r007
K0025	DC link voltage		r006
K0030	Control word 1	Control word 1	r550
K0031	Control word 2	Control word 2 (bits 16-31)	r551
K0032	Status word 1	Status word 1	r552
K0033	Status word 2	Status word 2 (bits 16-31)	r553

5.9.4 Other drive converter parameters

K0236	Ud(act.,smoothed)		-
K0238	Phase current 1		r832.1
K0239	Phase current 2		r832.2
K0240	U _{DC} (act)	DC link voltage	
K0241	M(act)	M act ?	
K0242	I(absolute output)		
K0244	Motor utilization		r008
K0245	Motor temperature	Motor temperature KTY sensor	r009
K0247	Converter temp.		r833
K0248	Free computation time	Free computation time	r829
K0249	Converter status		r001

5.9.5 Setpoint channel speed/frequency

KK0040	Actual FSW	Connector with the currently valid fixed setpoint (can be selected using the function data set and fixed setpoint bits)	-
KK0058	Mot.poti(output)	Motorized potentiometer output value	-
KK0067	Suppl. setpoint 1	Supplementary setpoint 1; is added to the main setpoint in front of the ramp-function generator	-
KK0068	Suppl. setpoint 2	Supplementary setpoint 2 ; is added to the main setpoint in front of the ramp-function generator	-
KK0069	Main setpoint	Main setpoint	-
KK0070	n(set,sum1)	Setpoint after the summing point 1	-
KK0071	n(set,DR select)	Setpoint after the summing point 2	-
KK0072	n(set,RFG-I)	Setpoint at the ramp-function generator input	-
KK0073	n(set,RFG-O)	Setpoint at the ramp-function generator output	-
KK0074	n(set,sum2)	Setpoint after the summing point 3	-
KK0075	n/f(set)	Setpoint after limiting to n/f(max) pos./neg. direction of rotation	-

5.9.6 Setpoint channel torque/current

K0077	T(accel.)	Pre-control torque (moment of inertia compensation)	-
K0080	T setpoint	Torque setpoint, slave drive	-
K0081	T limit 1	Maximum value of the upper torque limit	-
K0082	Tmax	Upper torque limit	-
K0083	T limit 2	Maximum value of the lower torque limit	-
K0084	Tmax2	Lower torque limit	-
K0085	I suppl. setpoint	Supplementary current setpoint	-
K0086	T suppl. setpoint	Supplementary torque setpoint	-
K0087	T suppl. FSW	Fixed setpoint for the supplementary torque setpoint	-
K0088	I suppl. FSW	Fixed setpoint for the supplementary current setpoint	-

5.9.7 Actual values speed/frequency

K0090	Rotor angle	Mechanical angle	r0186
KK0091	Speed/frequency (act.,encoder)	Actual speed	-
K0092	Flux angle diff.		-
K0093	Load angle		-
K0120	Position angle	Position actual value from the motor encoder, in units of length	r0185
K0148	n/f(act)		-
K0149	n/f(precontrol)		-
K0150	n/f(set,smooth.)	Smoothed speed setpoint in front of the setpoint-actual value comparison, speed controller	-
K0151	n/f(set,act)	Smoothed speed actual value in front of the setpoint-actual value comparison, speed controller	-

5.9.8 Closed-loop control

KK0152	n/f(control diff.)	Setpoint-actual value difference at the speed controller input	-
KK0153	T(set,n/f reg)	Speed controller output	-
K00158	n/f (bandstop)	Speed actual value after filtering by the bandstop	-
K0159	Output DT1 element	Output of the DT1 element, speed controller	-
K0164	T(set,precontrol)		-
K0165	T(set,limit)	Output connector, torque limiting	-
K0167	lsq(set,limit)	Setpoint-torque-generating current after the torque- and current limiting	-
K0178	l(set,smooth)		-
K0179	lsd(set)		-
K0182	lsd(act)	Actual value of the flux-generating current	-
K0184	lsq(act)	Actual value of the torque-generating current	-
KK0188	f(slip)	Slip speed	-
KK0199	f(set,stator)		-
KK0200	f(set,V/Hz)	Setpoint frequency V/f characteristic (V/Hz) mode	-
KK0208	Imax reg (output)	Output i(max) controller for V/f characteristic	-
K0209	Imax reg(output)U		-
K0210	lexc(set)		-
K0211	lexc(act)		-
K0222	Modulation	Absolute modulation depth	-

6 Drive converter functions (WEA, KIP, FLN...)

6.1 Automatic restart (WEA)

	CU1/2	CUVC
WEA on/off	P366	P373
WEA delay time	P367	P374

6.2 Kinetic buffering (KIP) / flexible response (FLN)

	CU1/2	CUVC
KIP/FLN	P379	P517
KIP/FLN ,start of	P380	P518
KIP/FLN dyn. controller	P381	P519
KIP/FLN/Udmax reg. Kp	P382	P520
KIP/FLN/Udmax reg. Ti	P383	P521
KIP/FLN/Udmax reg. Td	P384	P522
f (KIP/FLN/Udmax)	r385	-
I (KIP/FLN/Udmax)	r386	-
FLN Uadmin	P387	P523

6.3 Closed-loop Udmax control

	CU1/2	CUVC
Udmax controller	P377	P515
Udmax reg. dyn.	P378	P516

6.4 DC current braking (DC brake)

	CU1/2	CUVC
De-energization time	P371	P603
DC brake	P372	P395
DC braking current	P373	P396
DC braking duration	P374	P397
Frequency at the start of DC braking	P375	P398

6.5 Restart-on-the-fly

	CU1/2	CUVC
S. restart-on-the-fly enable	P583	P583
Restart-on-the-fly, standstill	(P386)	P524
Restart-on-the-fly, search current	P369	P525
Restart-on-the-fly, search speed	P370	P526
Restart-on-the-fly, stimul	(P376)	P527

6.6 Synchronization (Sync.)

	CU1/2	CUVC
S.sync enable	P582	P582
Sync. status	r388	r528
Sync. start delta f	P389	P529
Sync. reference angle	P390	P530
Sync. window	P391	P531
Sync. delta fmax	P392	P532
Sync. target frequency	r393	r533

6.7 Technology controller

	CU1/2	CUVC
Technol. setpoint	P525 - r529	not used ¹⁾
Technol. actual value	P530 - r534	not used ¹⁾
Technol. setp./act. val. comparison	P535 - r536	not used ¹⁾
PID controller	P537 - r545	not used ¹⁾

1) *The technology controller is replaced by configuring free function blocks*

6.8 Open-loop brake control

	CU1/2	CUVC
Brake (open-loop) control	not used	P605
Brake opening time	not used	P606
Brake closing time	not used	P607
S.open brake	not used	P608
S.close brake	not used	P609
S.brake, threshold 1	not used	P610
Brake threshold 1	not used	P611
S.checkback signal brake open	not used	P612
S.checkb. signal brake closed	not used	P613
S.stop brake closed	not used	P614
S.brake threshold 2	not used	P615
Brake threshold 2	not used	P616
Brake threshold 2 time	not used	P617

7 Function Diagrams

8 Lists (BDS, FDS, MDS, Binector, Connector)

9 Parameter List

10 Cross-Reference-Lists

10.1 Converting CU2 parameters to CUVC parameters

Allgemeine Beobachtungsparameter	bis 49	Analoge Ein-/Ausgabe	ab 650
Allgemeine Parameter	ab 50	Schnittstellenkonfiguration	ab 680
Gerätedaten	ab 70	Diagnosefunktionen	ab 720
Hardware-Konfiguration	ab 89	Steuersatz	ab 760
Motordaten	ab 100	Werkparameter	ab 780
Regelung	ab 135	Sonderparameter	ab 800
Funktionen	ab 330	Profilparameter	ab 900
Sollwertkanal	ab 410	Technologie Parameter	ab 1000
Steuer- und Zustandsbitverdrahtung	ab 550		

Die Parameternummern der CUVC enthalten **nur in dieser Tabelle** zur Unterscheidung ein 'N' hinter den Bezeichnern 'P' und 'r'

PNU *:Best-P	OP1-Parametername Beschreibung		PNU VC NEU *:Best-PN	BICO Nr.
r000	Betriebsanzeige		rN000	
r001	Umrichterzustand		rN001	K0249
r003	Ausgangsspannung		rN003	K0021 geglättet
r004	Ausgangsstrom		rN004	K0022 geglättet
r005	Ausgangsleistung		rN005	K0023 geglättet
r006	Zwischenkreisspg		rN006	K0025 geglättet
r007	Drehmoment		rN007	K0024 geglättet
r008	Motorauslastung		rN008	K0244
r009	Motortemperatur		rN009	K0245
r010	Umr.Auslastung		rN010	K0246
r011	Umr.Temperatur		rN833	K0247
r012	Grund/Reserve		rN012	---
r013	Betriebsstunden		rN825	---
P050	Sprache		PN050	
P051	Zugriffsstufe	entfällt		
P052	Funktionsanwahl		PN060, PN115	
P053	Parametrierfreig		PN053	
P054	OP-Hinterleuchtg		PN054	

PNU *:Best-P	OP1-Parametername Beschreibung		PNU VC NEU *:Best-PN	BICO Nr.
P070	MLFB(6SE70..)		PN070	
P071	Umr.Anschlußspg.		PN071	
P072	Umr.Strom(n)		PN072	
P073	Umr.Leistung(n)		PN073	
P077	Werkseinst.-Typ		PN366	
r089	Baugr. Steckpl.1	entfällt		
P090	Baugr. Steckpl.2	entfällt		
P091	Baugr. Steckpl.3			
P092	Ausgangsfiler		PN068	
P100	Motortyp		PN095	
P101	Mot.Spannung(n)		PN101	
P102	Mot.Strom(n)		PN102	
P103	Mot.Leerl.Strom		PN103	
P104	Mot.CosPhi(n)		PN104	
P105	Mot.Leistung(n)		PN105	
P106	Mot.Wirk.Grad(n)		PN106	
P107	Mot.Frequenz(n)		PN107	
P108	Mot.Drehzahl(n)		PN108	
P109	Mot.Polpaarzahl		PN109	
P110	kT(n)		PN088	
P120	X(haupt,d) ges.		PN075	
P121	X(haupt,q) ges.		PN076	
P122	X(sigma,d) Dämpf		PN077	
P123	X(sigma,q) Dämpf		PN078	
P124	R(Dämpfung,d)		PN079	
P125	R(Dämpfung,q)		PN080	
P126	Psi(Sätt.Kl.,1)		PN082	
P127	Ierr(Sätt.Kl.,1)		PN083	
P128	Psi(Sätt.Kl.,2)		PN084	
P129	Ierr(Sätt.Kl.,2)		PN085	
P130	Psi(Sätt.Kl.,3)		PN086	
P131	Ierr(Sätt.Kl.,3)		PN087	
P133	Ierr(0)/Ierr(n)		PN081	
P137	n (n/f-Reg.) KL1		PN233	
P138	n (n/f-Reg.) KL2		PN234	
P139	Kp(n/f-Reg.) KL2		PN236	
P140	Fluß-Reg. Kp		PN297	
P141	Fluß-Reg. Tn		PN298	
r142	dIerr(sd)			K0212
P143	Q. i(Erregung)		PN155	
P144	i(Erregung) Kp	entfällt		
r145	Ierr(ist)		rN156	K0211
P146	i(Err.)-Reg. Kp		PN157	

PNU *:Best-P	OP1-Parametername Beschreibung		PNU VC NEU *:Best-PN	BICO Nr.
P147	i(Err.,mindest)		PN158	
P148	Glätt. dl(Err)		PN159	
r149	lerr(soll)		rN160	K0210
r150	Regelungszustand Bit00=1: Hochlaufgeber Setzbefehl aktiv Bit01=1: Antrieb in der Feldschwächung Bit02=1: Ud(min)-Regler aktiv (kin. Pufferung) Bit03=1: Ud(max)-Regler aktiv Bit04=1: Frequenzbegrenzung greift ein Bit05=1: Hochlaufgeber, Hochlaufsperr aktiv Bit06=1: Hochlaufgeber, Rücklaufsperr aktiv Bit07=1: Drehzahlregler-Ausgang an oberer Begrenzung Bit08=1: Drehzahlregler-Ausgang an unterer Begrenzung Bit09=1: Schutzhochlaufgeber aktiv Bit10=1: i(max)-Regler aktiv Bit11=1: Initialisierung der Regelung fertig Bit12=1: Drehzahlregler-Ausgang Setzbefehl für I-Anteil aktiv Bit13=1: Wirkstrombegrenzung durch Kippgrenze reduziert Bit14=1: EMK-Regler I-Anteil an Begrenzung Bit15=1: Motor gekippt oder blockiert			B0237 B0251 B0295 B0296 B0254 B0238 B0239 B0231 B0232 B0240 B0236 - B0229 B0235 B0252 B0156
r152	Aktiver MDS		rN011	---
P155	Filter f(Reso.)		PN254	
P156	FilterBandbreite		PN253	
P157	Filter Kp		PN251	
P158	Q.Anfangswinkel		PN172	
r159	Rotorwinkel		rN186	KK0090
r160	Lagewinkel		rN185	KK0120
P161	T(tot,Läuf.wink)		PN187	
r162	Flußwinkel-Diff.			K0162
P163	Steuer/Regel-Art		PN100	
P165	Kennlinie		PN330	
P166	Anhebung		PN318	
P167	Anhebung Strom		PN319	
P168	AnhebungSpannung		PN325	
P169	Anhebeendfrq.		PN326	
P170	Feldschw.Frq.		PN293	
P171	Beschl.Strom		PN322	
P172	lxR-Komp. Kp		PN334	
P173	lmax		PN128	
r174	lmax(soll)		rN129	K0175
P175	lmax-Regler Kp		PN331	
P176	lmax-Regler Tn		PN332	
r177	f(lmax-Reg.)			K0208

PNU *:Best-P	OP1-Parametername Beschreibung		PNU VC NEU *:Best-PN	BICO Nr.
r178	U(lmax-Reg.)			K0209
r179	I Ausg. (Betrag)			K0242
r180	Aussteuergrenze		rN345	K0190
r181	Max. Ausg.Spg.		rN346	K0191
r182	FeldschwFrq(ist)			K0192
P183	Psi(soll)		PN291	
r184	Psi(Kennlinie)			K0193
P185	Min.lastabh.Fluß		PN295	
P186	Glätt. Psi(ist)		PN301	
r187	Psi(ist)		rN302	K0181
r188	Psi(lastabh.)			K0194
P189	Erregungszeit		PN602	
P190	Sanftanlauf		PN604	
P191	Glätt. Psi(soll)		PN303	
r192	Psi(soll,glatt)			K0195
P193	Feldschw.-Reg Ti		PN305	
r194	Psi(FeldschwReg)			K0196
r195	Psi(soll,gesamt)		rN304	K0197
r196	Leerlaufstrom		rN119	---
P197	X(haupt)		PN120	
P198	R(Läufer) Ktmp		PN127	
r199	R(Läufer)		rN126	---
r200	T(Läufer)		rN124	---
r201	Isd(statisch)			K0177
P202	M(statisch)		PN278	
P203	M(dynamisch)		PN279	
P204	Glättung I(soll)		PN280	
r205	I(soll,glatt)			K0178
r206	Isd(soll)		rN281	K0179
P207	Q. n/f(ist)		PN222	
P208	Q.Drehzahlistw.		PN130	
P209	Impg. Strichzahl		PN151	
P210	Ana.Tacho Abgl.		PN138	
r214	n(ist,Geber)			KK0091
P215	dn(ist,zulässig)		PN215	
P216	Glätt n/f(Vorst)		PN216	
P217	SchleppfKorr.		PN217	
r218	n/f(ist)		rN218	KK0148
r219	n(ist)		rN219	
r220	n/f(Vorst)			KK0149
P221	Glätt. n/f(ist)		PN223	
r222	n/f(ist,glatt)		rN230	KK0151
r223	n/f(soll,Reg)		rN229	KK0150

PNU *:Best-P	OP1-Parametername Beschreibung		PNU VC NEU *:Best-PN	BICO Nr.
r224	n/f-Regeldiff			KK0152
P225	n/f-Reg. Kp		PN235	
P226	Q.n/f-Reg.Adap.		PN231	
P227	n/f-Reg.Adap. Kp	entfällt		
r228	n/f-Reg. Kp(ist)		rN237	----
P229	n/f-Reg. Tn		PN240	
P230	Pwmax(mot)		PN258	
P231	Kp Isq(max)		PN268	
P232	Isq(soll)-Grad.		PN274	
P233	Pwmax(gen)		PN259	
r234	Isqmax			K0176
r235	Mmax(n/f-Reg.)			K0172
r236	Mmin(n/f-Reg.)			K0173
r237	M(n/f-Reg.,i)			K0155
r238	M(soll,Reg.-Aus)		rN255	K0153
P239	EMK(max)		PN306	
P240	EMK(max.)-Reg Ti		PN307	
P241	Glätt. n/f(soll)		PN221	
P242	Anlaufzeit		PN116	
P243	n/f-Reg.Vorst Kp		PN471	
r244	M(soll,zusatz)			K0164
r245	M(soll,sum)		rN269	K0165
r246	Isq(soll)		rN272	K0167
P247	Statik		PN245	
P248	Statik Kp		PN246	
r249	n/f(Statik)			KK0157
P250	n-Dämpfung Kd		PN250	
P251	Glätt n-Dämpfung		PN249	
r252	dlsq (Dämpfung)			KK0159
P253	Strom-Reg. Kp		PN283	
P254	Strom-Reg. Tn		PN284	
r255	Isd(soll,glatt)			K0183
r256	Isd(ist)			K0182
r257	Umax(Isd-Reg.)			K0217
r258	Usd(Isd-Reg.)			K0218
r259	Usd(Isd-Reg.,i)			K0219
P261	Glättung Isq		PN335	
P262	Glätt. Isq(soll)		PN273	
r263	Isq(soll,glatt)			K0168
r264	Isq(ist)			K0184
r265	Usq(Isq-Reg.)			K0220
r266	Usq(Isq-Reg.,i)			K0221
r268	Phasenstrom 1		rN832	K0238

PNU *:Best-P	OP1-Parametername Beschreibung		PNU VC NEU *:Best-PN	BICO Nr.
r269	Phasenstrom 3		rN832	K0239
P270	R(Leitung)		PN117	
r271	R(Ständer,ges)		rN118	---
P272	R(Ständer+Ltg)		PN121	
P273	X(sigma)		PN122	
r274	T(sigma)		rN125	---
P275	Entkopplung Kp 1		PN288	
P276	Entkopplung Kp 2		PN289	
r277	Usd(Entkoppl.)			K0228
P278	Kp L(sig,U-Mod.)		PN312	
P279	Kp X(sig,U-Mod.)	entfällt		
r280	Alpha(soll)			K0229
P281	i(Betr.,mindest)		PN161	
P282	df(Umsch,CosPhi)		PN162	
P283	Phi(innen)	entfällt		
P284	f(Umsch.EMK-Mod)		PN313	
P285	f(Umsch.I-Mod.)		PN314	
r286	Motormodell			B0253
P287	EMK-Reg. Kp		PN315	
r288	EMK-Reg. Kp(ist)			K0230
P289	EMK-Reg. Tn		PN316	
r290	fmax(EMK-Reg.)			K0232
r291	f(EMK-Reg.,p)			K0233
r292	f(EMK-Reg.,i)			K0234
r293	EMKsd			K0231
P294	Schlupfkomp. Kp		PN336	
r295	Mot.Schlupf(n)		rN110	---
r296	Schlupffrequenz			K0188
r297	f(soll,Ständer)			K0199
r298	f(soll,Steuers.)			KK0200
P299	Reson.Dämpfg. Kp		PN337	
P300	Dämpfung Kp		PN337	
r301	f(Reson.Dämpfg)			K0235
P302	Glättung Ud(ist)		PN287	
r303	Ud(ist)			K0240
r304	Ud(ist,glatt)			K0236
r305	Psi(soll,I-Mod.)		rN308	K0180
r306	Psi(ist,I-Mod.)		rN309	K0198
r307	Netzspannung(n)	entfällt	---	---
P308	Abtastzeit		PN357	
P309	Kp Tdd		PN166	
P310	R(Lauf)-TmpAdapt		PN386	
P311	Motorreihe		PN387	

PNU *:Best-P	OP1-Parametername Beschreibung		PNU VC NEU *:Best-PN	BICO Nr.
P312	Motorgewicht		PN388	
P313	Innenlüfter		PN389	
P314	K(Übertemp.)		PN390	
P315	Pv(Eisen)		PN392	
r316	Modelltemperatur		rN393	---
P317	K(ÜTemp.,Läufer)		PN391	
P318	Kp Tdq		PN167	
P319	Psi(Mod)-Reg. Kp		PN310	
P320	Psi(Mod)-Reg. Tn		PN311	
r321	l _{pd} (I-Mod.-Reg.)			K0213
r322	l _{pd} (I-Mod-Reg,i)			K0214
r323	l _{pd} (soll,I-Mod.)			K0215
r324	l _{pq} (soll,I-Mod.)			K0216
r325	Lastwinkel		rN168	K093
P326	Psi-Reg. Kp		PN163	
P327	U(max)-Reg. Kp		PN164	
P328	EMK(max)-Reg. Kp		PN165	
r329	d _{lsd} (soll,P-Reg)			K0229
r333	Meßabschnitt		rN377	---
r334	MotId R(Ständer)		rN541	---
r335	MotId R(Läufer)		rN542	---
r337	MotId Ventilspg.		rN543	---
r338	MotId Querspg.		rN544	---
r339	MotId Totzeit		rN545	---
r340	MotId X(sigma)		rN546	---
r341	Zk. Ausgleichsfk		rN547	---
r344	Testpulse Erg.		rN539	---
r345	Tachotest Erg.		rN540	---
P346	n/f-RegDyn(soll)		PN536	
P347	n/f-Reg.Dyn(ist)		PN537	
P348	n/f-Reg.Schw.frq		PN538	
P354	Erdschlußtest		PN375	
r358	Erdschl. Erg.		rN376	---
P359	Umgeb.Temperatur		PN379	
P360	Mot.Tmp.Warnung		PN380	
P361	Mot.Tmp.Störung		PN381	
P362	Motorkühlung		PN382	
P363	Mot.Tmp. T1		PN383	
P364	Mot.Lastgrenzen		PN384	
P365	Q.Motortemp.		PN385	
P366	WEA		PN373	
P367	WEA Wartezeit		PN374	
P368	(FangenStill)		PN524	

PNU *:Best-P	OP1-Parametername Beschreibung		PNU VC NEU *:Best-PN	BICO Nr.
P369	Fang. Suchstrom		PN525	
P370	Fang. Suchgeschw		PN526	
P371	Entregungszeit		PN603	
P372	DC-Bremse		PN395	
P373	DC-Bremstrom		PN396	
P374	DC-Bremsdauer		PN397	
P375	DC-Br.Einsatzfrq		PN398	
P376	(FangStmul)		PN527	
P377	Udmax-Regler		PN515	
P378	Udmax-Reg. Dyn.		PN516	
P379	KIP/FLN		PN517	
P380	KIP/FLN Eins.Pkt		PN518	
P381	KIP/FLN Reg.Dyn.		PN519	
P382	KIP/FLN/Udmax-Reg Kp		PN520	
P383	KIP/FLN/Udmax-Reg Ti		PN521	
P384	KIP/FLN/Udmax-Reg Td		PN522	
r385	f(KIP/FLN/Udmax)			K0270
r386	I(KIP/UdmaxReg)			K0271
P387	FLN Uadmin		PN523	
r388	Sync. Zustand 0 : Synchronisierung ausgeschaltet 1 : Frequenzmessung aktiv 2 : Phasenregelung aktiv 3 : Synchronität erreicht 4 : Synchronisierfehler		rN528	B0297 B0298 B0299 - -
P389	SyncStartDelta f		PN529	
P390	Sync. Sollwinkel		PN530	
P391	Sync. Fenster		PN531	
P392	Sync. Delta fmax		PN532	
r393	Sync. Zielfrq.		rN533	K0275
r394	Sync. Phasendiff			K0276
P395	Selektivität		PN371	
P399	HS-Rückmeldezeit		PN600	
r410	Aktiver SDS		rN013	---
P420	Anlagennennfrq.		PN352	
P421	Festsollwert 1		PN401	KK0041
P422	Festsollwert 2		PN402	KK0042
P423	Festsollwert 3		PN403	KK0043
P424	Festsollwert 4		PN404	KK0044
P425	Motpot Speichrg.		PN425	
P426	Motpot Startfrq.		PN426	
P427	Motorpoti setzen		PN427	
P433	Q.Zusatzsollw. 1		PN433	
P434	Zusatzsollw.1 Kp		PN434	

PNU *:Best-P	OP1-Parametername Beschreibung		PNU VC NEU *:Best-PN	BICO Nr.
r437	Zusatzsollwert 1		rN437	KK0067
P438	Q.Zusatzsollw. 2		PN438	
P439	Zusatzsollw.2 Kp		PN439	
r442	Zusatzsollwert 2		rN442	KK0068
P443	Q. Hauptsollwert		PN443	
P444	Hauptsollwert Kp		PN444	
P445	Grundsollwert	entfällt		
r447	Hauptsollwert		rN447	KK0069
P448	Tippfrequenz 1		PN448	
P449	Tippfrequenz 2		PN449	
r451	n/f(soll,sum1)		rN451	KK0070
P452	Maximalfrq.(RDF)		PN452	
P453	Maximalfrq.(LDF)		PN453	
P455	Ausblendfrequenz		PN455	
P456	Ausblendband		PN456	
P457	Minimalfrequenz		PN457	
r460	n/f(soll,HLG-E.)		rN460	KK0072
r461	HLG Zustand 0 : Hochlaufgeber gesperrt 1 : Hochlaufgeber freigegeben 2 : Hochlaufgeber angehalten 4 : Hochlaufgeber gesetzt 5 : Hochlaufgeber nachgeführt			B0205 B0206 B0207 B0208 B0209
P462	Hochlaufzeit		PN462	
P463	Einheit HL-Zeit		PN463	
P464	Rücklaufzeit		PN464	
P465	Einheit RL-Zeit		PN465	
P466	AUS3 RL-Zeit		PN466	
P467	Schutz-HL Kp		PN467	
P469	Anf.Verrundung		PN469	
P470	Endverrundung		PN470	
P475	HLG-Nachführung		PN475	
P476	HLG aktiv Hys.		PN476	
r480	n/f(soll,HLG-A.)		rN480	KK0073
r481	n/f(soll,sum2)		rN481	KK0074
r482	n/f(soll)		rN482	KK0075
P485	Anlagennenn-M		PN354	
P486	Q.M-Sollwert		PN486	
P487	M-Sollwert Kp		PN487	
r490	M-Sollwert		rN490	K0080
P492	Mgrenz 1 FSW		PN492	
P493	Q.Mgrenz 1		PN493	
P494	Mgrenz 1 Kp		PN494	
r496	Mgrenz 1		rN496	K0081

PNU *:Best-P	OP1-Parametername Beschreibung		PNU VC NEU *:Best-PN	BICO Nr.
r497	Mmax 1		rN497	K0082
P498	Mgrenz 2 FSW		PN498	
P499	Q.Mgrenz 2		PN499	
P500	Mgrenz 2 Kp		PN500	
r502	Mgrenz 2		rN502	K0083
r503	Mmax 2		rN503	K0084
P505	M/I-Festsollwert	M-ZusatzFSW	PN505	
P506	Q.M/I-Zus.Sollw.	Q.M-Zus.Sollw.	PN506	
P507	M/I-Zus.Sollw Kp	Skal M-ZusSollw	PN507	
P508	Anwahl M-Zusatz	entfällt		
r510	M/I-Zusatzsollw.	M-Zusatzsollw.	rN510	K0086
P512	Vergl.Frq.		PN796	
P513	Vergl.Frq. Hys.		PN797	
P514	AUS-Abschaltfrq.		PN800	
P516	AUS-Wartezeit		PN801	
P517	Soll-Ist-Abw Frq		PN792	
P518	Soll-Ist-AbwZeit		PN794	
P519	Überdrehzahl Hys		PN804	
P520	Kipp/Blick. Zeit		PN805	
P525	T.Reg.Festsollw.	entfällt		
P526	Q.T.Reg.Sollwert	entfällt		
P527	T.Reg.Sollw.Kp	entfällt		
P528	T.Reg.Soll.Glätt	entfällt		
r529	T.Reg.Sollwert	entfällt		K
P530	T.Reg.Istwerte	entfällt		
P531	Q.T.Reg.Istwert	entfällt		
P532	T.Reg.Istw. Kp	entfällt		
P533	T.Reg.Istw. Glätt	entfällt		
r534	T.Reg.Istwert	entfällt		K
P535	T.Reg.Vergl.Hyst	entfällt		
r536	T.Reg.Regeldiff	entfällt		K
P537	T.Reg. Kp	entfällt		
P538	T.Reg. Tn	entfällt		
P539	T.Reg. Tv	entfällt		
r540	T.Reg.Ausgang	entfällt		K
P541	T.Reg.Aus.Grenz1	entfällt		
P542	T.Reg.Aus.Grenz2	entfällt		
P543	T.Reg.Gr1.HLZEIT	entfällt		
P544	T.Reg.Gr2.HLZEIT	entfällt		
r545	T.Reg.Aus.(begr)	entfällt		K
P546	T.Reg kp-Adapt.	entfällt		
r547	T.Reg kp akt	entfällt		K
r550	Steuerwort 1		rN550	K0030

PNU *:Best-P	OP1-Parametername Beschreibung		PNU VC NEU *:Best-PN	BICO Nr.
r551	Steuerwort 2		rN551	K0031
r552	Zustandswort 1		rN552	K0032
r553	Zustandswort 2		rN553	K0033
P554	Q.EIN/AUS1		PN554	
P555	Q.1 AUS2(Elektr)		PN555	
P556	Q.2 AUS2(Elektr)		PN556	
P557	Q.3 AUS2 (Elektr)		PN557	
P558	Q.1 AUS3 (SHalt)		PN558	
P559	Q.2 AUS3 (SHalt)		PN559	
P560	Q.3 AUS3 (SHalt)		PN560	
P561	Q.WR-Freigabe		PN561	
P562	Q.HLG-Freigabe		PN562	
P563	Q.kein HLG-Halt		PN563	
P564	Q.Sollw.Freigabe		PN564	
P565	Q.1 Quittieren		PN565	
P566	Q.2 Quittieren		PN566	
P567	Q.3 Quittieren		PN567	
P568	Q.Tippen1 EIN		PN568	
P569	Q.Tippen2 EIN		PN569	
P571	Q.Rechtsdrehfeld		PN571	
P572	Q.Linksdrehfeld		PN572	
P573	Q.Motpot. Höher		PN573	
P574	Q.Motpot. Tiefer		PN574	
P575	Q.k. Störg.ext.1		PN575	
P576	Q.SDS Bit 0		PN576	
P577	Q.SDS Bit 1		PN577	
P578	Q.MDS Bit 0		PN578	
P579	Q.MDS Bit 1		PN579	
P580	Q.FSW Bit 0		PN580	
P581	Q.FSW Bit 1		PN581	
P582	Q.Sync. Freigabe		PN582	
P583	Q.Fang. Freigabe		PN583	
P584	Q.Stat/T.RegFrei		PN584	
P585	Q.Reglerfreigabe		PN585	
P586	Q.k. Störg.ext.2		PN586	
P587	Q.Folgeantrieb		PN587	
P588	Q.k. Warng.ext.1		PN588	
P589	Q.k. Warng.ext.2		PN589	
P590	Q.Grund/Reserve		PN590	
P591	Q.HS-Rückmeldung		PN591	
P600	Z.Einsch.Bereit			B100,101
P601	Z.Betriebsbereit			B102,103
P602	Z.Betrieb			B104,105

PNU *:Best-P	OP1-Parametername Beschreibung		PNU VC NEU *:Best-PN	BICO Nr.
P603	Z.Störung			B106,107
P604	Z.kein AUS2			B108,109
P605	Z.kein AUS3			B110,111
P606	Z.Einsch.Sperre			B112,113
P607	Z.Warnung			B114,115
P608	Z.k.Soll-Ist-Abw			B116,117
P610	Z.Vergl.Frq err.			B120,121
P611	Z.Unterspannung			B122,123
P612	Z.HS angesteuert			B124,125
P613	Z.HLG aktiv			B126,127
P614	Z.Rechtdrehfeld			B128,129
P615	Z.KIP/FLN aktiv			B130,131
P616	Z.Fangen aktiv			B132,133
P617	Z.Sync. erreicht			B134,135
P618	Z.k. Überdrehz.			B136,137
P619	Z.Störg. ext. 1			B138,139
P620	Z.Störg. ext. 2			B140,141
P621	Z.Warng. ext.			B142,143
P622	Z.Warng. i2tUmr			B144,145
P623	Z.Störg. ÜTmUmr			B146,147
P624	Z.Warng. ÜTmUmr			B148,149
P625	Z.Warng. ÜTmMot			B150,151
P626	Z.Störg. ÜTmMot			B152,153
P627	Z.T.Reg.Soll.err			B154,155
P628	Z.Mot. Kipp/Blck			B156,157
P629	Z.ÜS angesteuert			B158,159
P630	Z.Sync.Fehler			B160,161
P631	Z.Vorladg. aktiv			B162,163
P650	CU-AE Konfig.		PN632	
P651	CU-AE Glättung		PN634	
P652	CU-AE Offset		PN631	
P655	CU-AA Istwerte		PN640	
P656	CU-AA Verst.		PN643	
P657	CU-AA Offset		PN644	
P660	SCI-AE Konfig.		PN690	
P661	SCI-AE Glättung		PN691	
P662	SCI-AE Offset		PN692	
P664	SCI-AA Istwerte		PN693	
P665	SCI-AA Verst.		PN694	
P666	SCI-AA Offset		PN695	
P680	SST1 Istwerte		PN707	
P681	SST2 Istwerte		PN708	
P682	SCB Protokoll		PN696	

PNU *:Best-P	OP1-Parametername Beschreibung		PNU VC NEU *:Best-PN	BICO Nr.
P683	SST/SCB Busadr.		PN700	
P684	SST/SCB Baudrate		PN701	
P685	SST/SCB PKW-Anz.		PN702	
P686	SST/SCB PZD-Anz.		PN703	
P687	SST/SCB TLG-Ausz		PN704	
P689	SCB Peerweiterg.		PN705	
P690	SCB Istwerte		PN706	
P692	<i>ReaktionTLGAusf.</i>	<i>entfällt</i>		
P694	CB/TB Istwerte		PN734	
P695	CB/TB TLG-Ausz.		PN722	
P696	CB Parameter 1		PN711	
P697	CB Parameter 2		PN712	
P698	CB Parameter 3		PN713	
P699	CB Parameter 4		PN714	
P700	CB Parameter 5		PN715	
P701	CB Parameter 6		PN716	
P702	CB Parameter 7		PN717	
P703	CB Parameter 8		PN718	
P704	CB Parameter 9		PN719	
P705	CB Parameter 10		PN720	
P706	CB Parameter 11		PN721	
r720	Softwareversion		rN069	---
r721	Generierungsdat.		rN827	---
r722	Softwarekennung		rN828	---
r723	Baugruppencode		rN826	---
r724	Baugr.-Kompatib.		rN824	---
r725	Freie Rechenzeit		rN829	K0248
r727	<i>Sollwerttabelle</i>	<i>entfällt</i>		---
r728	<i>akt. SDS/MDS/FSW</i>	<i>entfällt</i>		
r730	SCB Diagnose		rN697	?
r731	CB/TB Diagnose		rN732	?
P733	Simulations-Betr		PN372	
P735	TRC Triggerpar.		PN2880	
P736	TRC Triggerwert		PN2881	
P737	TRC Triggerbed.		PN2882	
P738	TRC Istwerte		PN2883	
P739	TRC Abtastzeit		PN2884	
P740	TRC Pretrigger		PN2885	
P741	TRC Start		PN2886	
r743	Störg. n/f(ist)		rN783	---
r744	Störg. dn/dt		rN784	---
r745	Störg. Isq(ist)		rN785	---
r746	Störg. U(soll)		rN786	---

PNU *:Best-P	OP1-Parametername Beschreibung		PNU VC NEU *:Best-PN	BICO Nr.
r747	Störg. Reg.Zust.		rN787	
r748	Störzeit		rN782	
P750	TRC Datenblock		PN2887	
r751	TRC Daten Kanal1		PN2888	
r752	TRC Daten Kanal2		PN2889	
r753	TRC Daten Kanal3		PN2890	
r754	TRC Daten Kanal4		PN2891	
r755	TRC Daten Kanal5		PN2892	
r756	TRC Daten Kanal6		PN2893	
r757	TRC Daten Kanal7		PN2894	
r758	TRC Daten Kanal8		PN2895	
r760	Steuersatzzust. Bit0 : 0: Raumzeigermodulation 1: Flankenmodulation Bit1 : 0: Pulslocking 1: Pulsdropping Bit2 : 0: Einzelphasenlöschung 1: Summenlöschung Bit3 : 0: Linksdrehfeld 1: Rechtsdrehfeld Bit4 : 0: asynchrone Modulation 1: synchrone Modulation Bit5 : 1: Übersteuerungsbereich Bit6,7 : unbenutzt Bit8 : Bit0 der Systemnummer in der Flankenmodulation Bit9 : Bit1 der Systemnummer in der Flankenmodulation Bit10 :Bit2 der Systemnummer in der Flankenmodulation Bit11 :Bit3 der Systemnummer in der Flankenmodulation Bit12..15 unbenutzt			B0320 - - - B0321 B0322 - B0323 B0324 B0325 B0326 -
P761	Pulsfrequenz		PN340	
P762	SIMO-Sound		PN341	
P763	Max.Aussteuergrd		PN342	
r764	Aussteuergrad		PN343	K0222, K0205
P765	Aussteuerreserve		PN344	
P766	T(Totzeitkomp.)		PN345	
P767	Gleichtaktkomp.		PN338	
P768	Ventilspg.Komp.		PN349	
P769	PulssystemFreig.		PN339	
P770	Totzeitkomp.		PN348	
P780	Störmaskierung		PN830	
P781	Testbetrieb		PN837	
P782	UCE/Ü/K-Test		PN837	
r783	UCE/Ü/K-Test Erg		rN838	---
P784	Parallel - Modus		PN847	

PNU *:Best-P	OP1-Parametername Beschreibung		PNU VC NEU *:Best-PN	BICO Nr.
P785	Test MultiParll.		PN848	
r786	StatusMultiParl.		rN849	---
P788	RAM-Zugr.Adr.		PN840	
P789	RAM-Zugr.Wert		PN841	
P790	MWHRAM-Zugr.Adr.		PN842	
P791	MWHRAM-ZugrWert		PN843	
P799	SF		PN399	
r860	zentrl. PNU-Lst.	entfällt		
r861	Menü-Liste	entfällt		
r862	Allg.BeobPar	entfällt		
r863	Allg. Par.	entfällt		
r864	Gerätedaten	entfällt		
r865	HW-Konfig.	entfällt		
r866	Motordaten	entfällt		
r867	Regelung	entfällt		
r868	Funktionen.	entfällt		
r869	Sollw.Kanal	entfällt		
r870	STW/ZUW	entfällt		
r871	Analoge E/A	entfällt		
r872	Schnittst.	entfällt		
r873	Diagnose	entfällt		
r874	Steuersatz	entfällt		
r875	Werkspar.	entfällt		
r876	Sonderpar.	entfällt		
r877	Profilpar.	entfällt		
r878	Tech.Par.	entfällt		
r881	PWE-Betriebsanz.	entfällt		
r882	PWE Sollw.Par.	entfällt		
r883	PWE STW-Par.	entfällt		
r884	PWE ZUW int	entfällt		
r885	PWE ZUW ser	entfällt		
r886	PWE ZUW TSY	entfällt		
r887	L2-Text SW	entfällt		
r888	L2-Text STW	entfällt		
r889	L2-Text ZUW int	entfällt		
r890	L2-Text ZUW ser	entfällt		
r891	L2-Text ZUW TSY	entfällt		
r892	Gültige PNU-PWE	entfällt		
r893	Meldekennung	entfällt		
P899	OP-Parametrierg.	entfällt		
P917	Spontanmeldung	entfällt		
P918	CB Busadresse		PN918	
P927	Parametrierfreig		PN927	

PNU *:Best-P	OP1-Parametername Beschreibung		PNU VC NEU *:Best-PN	BICO Nr.
P928	Q.Grund/Reserve	entfällt		
r947	Störspeicher		rN947	
r949	Störwert		rN949	
r951	Störtextrliste		rN951	
P952	Anzahl Störfälle		PN952	
r953	Warnparameter 1		rN953	
r954	Warnparameter 2		rN954	
r955	Warnparameter 3		rN955	
r956	Warnparameter 4		rN956	
r957	Warnparameter 5		rN957	
r958	Warnparameter 6		rN958	
r959	Warnparameter 7		rN959	
r960	Warnparameter 8		rN960	
r964	Geräteident.		rN964	
r965	Profilnummer		rN965	
r967	Steuerwort 1		rN967	
r968	Zustandswort 1		rN968	
P970	Werkseinstellung		PN970	
P971	EEPROM-Übernahm.		PN971	
r980	PNU-Lst. 1 vorh.		rN980	
r981	PNU-Lst. 2 vorh.		rN981	
r982	PNU-Lst. 3 vorh.		rN982	
r983	PNU-Lst. 4 vorh.		rN983	
r984	PNU-Lst. 5 vorh.		rN984	
r985	PNU-Lst. 6 vorh.		rN985	
r986	PNU-Lst. 7 vorh.		rN986	
r987	PNU-Lst. 8 vorh.		rN987	
r988	PNU-Lst. 9 vorh.		rN988	
r989	PNU-Lst.10 vorh.		rN989	
r990	PNU-Lst.1 geändert.		rN990	
r991	PNU-Lst.2 geändert.		rN991	
r992	PNU-Lst.3 geändert.		rN992	

10.2 Converting CUVC parameters to CU2 parameters

PNU	OP1-Parametername ALLGEMEINE PARAMETER	OP1-Parametername	PNU	BICO
VC neu	Beschreibung neu	Beschreibung alt	VC alt	
r000	“Betriebsanzeige”	“Betriebsanzeige”	r000	
r001	Umrichterzustand	Umrichterzustand	r001	K0249
r002	Drehfrequenz	Istdrehzahl		KK0020 geglättet
r003	Ausgangsspannung	Ausgangsspannung	r003	K0021 geglättet
r004	Ausgangsstrom	Ausgangsstrom	r004	K0022 geglättet
r005	Ausgangsleistung	Ausgangsleistung	r005	K0023 geglättet
r006	Zwischenkreisspg	Zwischenkreisspg	r006	K0025 geglättet
r007	Drehmoment	Drehmoment	r007	K0024 geglättet
r008	Motorauslastung	Motorauslastung	r008	K0244
r009	Motortemperatur	Motortemperatur	r009	K0245
r010	Umr.Auslastung	Umr.Auslastung	r010	K0246
r011	akt.Motor.Datens	aktiver MDS	r152	---
r012	akt.BICO-Datens.	Grund/Reserve	r012	---
r013	akt.Fkt.-Datens.	aktiver SDS	r410	---
r014	Solldrehzahl	n/f(soll,Reg)	r223	KK0150
r015	Istdrehzahl	Istdrehzahl		KK0020 geglättet
P050	Sprache	Sprache	P050	
P053	Parametrierfreig	Parametrierfreig	P053	
P054	OP-Hinterleuchtung	OP-Hinterleuchtung	P054	
P060	Menüauswahl (andere Bedeutung)	Funktionsanwahl	P052	
P068	Ausgangsfilter	Ausgangsfilter	P092	
P069	Softwareversion	Softwareversion	P720	---
P070	Best.Nr.6SE70..	MLFB(6SE70..)	P070	
P071	Umr.Anschlußspg.	Umr.Anschlußspg.	P071	
P072	Umr.Strom(n)	Umr.Strom(n)	P072	
P073	Umr.Leistung(n)	Umr.Leistung(n)	P073	
P075	X(haupt,d)ges	X(haupt,d)ges	P120	
P076	X(haupt,q)ges	X(haupt,q)ges	P121	
P077	X(sigma,d)Dämpf	X(sigma,d)Dämpf	P122	
P078	X(sigma,q)Dämpf	X(sigma,q)Dämpf	P123	
P079	R(Dämpfung,d)	R(Dämpfung,d)	P124	
P080	R(Dämpfung,q)	R(Dämpfung,q)	P125	
P081	ierr(0)/ierr(n)	ierr(0)/ierr(n)	P133	
P082	Psi(sätt,Kl.1)	Psi(sätt,Kl.1)	P126	

PNU	OP1-Parametername ALLGEMEINE PARAMETER	OP1-Parametername	PNU	BICO
VC neu	Beschreibung neu	Beschreibung alt	VC alt	
P083	lerr(sätt,Kl.1)	lerr(sätt,Kl.1)	P127	
P084	Psi(sätt,Kl.2)	Psi(sätt,Kl.2)	P128	
P085	lerr(sätt,Kl.2)	lerr(sätt,Kl.2)	P129	
P086	Psi(sätt,Kl.3)	Psi(sätt,Kl.3)	P130	
P087	lerr(sätt,Kl.3)	lerr(sätt,Kl.3)	P131	
P088	kT(n)	kT(n)	P110	
P095	Auswahl Motorart		P100	
	Ausw. 1FK6/1FT6			
(P097)	Auswahl 1PA6/1PL6			
P100	Steuer/Regel-Art	Steuer/Regel-Art	P163	
P101	Mot.Spannung(n)	Mot.Spannung(n)	P101	
P102	Mot.Strom(n)	Mot.Strom(n)	P102	
P103	Mot.Leerl.Strom	Mot.Leerl.Strom	P103	
P104	Mot.CosPhi(n)	Mot.CosPhi(n)	P104	
P105	Mot.Leistung(n)	Mot.Leistung(n)	P105	
P106	Mot.Wirk.Grad(n)	Mot.Wirk.Grad(n)	P106	
P107	Mot.Frequenz(n)	Mot.Frequenz(n)	P107	
P108	Mot.Drehzahl(n)	Mot.Drehzahl(n)	P108	
P109	Mot.Polpaarzahl	Mot.Polpaarzahl	P109	
r110	Mot.Schlupf(n)	Mot.Schlupf(n)	r295	---
P115	Berech.MotModell (Nummern gleich lassen bzgl. AutPa...)		(P052)	
P116	Anlaufzeit	Anlaufzeit	P242	
P117	R(Leitung)	R(Leitung)	P270	
r118	ges.Ständerwiderst.	R(Ständer,ges)	r271	---
r119	Magnetis.Strom	Leerlaufstrom	r196	---
P120	Hauptreaktanz	X(haupt)	P197	
P121	Ständerwiderst.	R(Ständer+Ltg)	P272	
P122	Ges.Streureakt.	X(sigma)	P273	
	Ständerreaktanz			
r124	T(Läufer)	T(Läufer)	r200	---
r125	T(sigma)	T(sigma)	r274	---
r126	R(Läufer)	R(Läufer)	r199	---
P127	R(Läufer)Ktmp	R(Läufer)Ktmp	P198	
P128	Maximalstrom	Imax	P173	
r129	Imax(soll)	Imax(soll)	r174	K0175
P130	Ausw.Motorgeber	Q.Drehzahlistw.	P208	
P138	Ana.Tacho.Abgl.	Ana.Tacho.Abgl.	P210	
P151	Strichzahl	Impg. Strichzahl	P209	
P155	Q.i(Erregung) (MC andere Bedeutung)	Q.i(Erregung)	P143	
r156	lerr(ist) (MC andere Bedeutung)	lerr(ist)	r145	K0136

PNU	OP1-Parametername ALLGEMEINE PARAMETER	OP1-Parametername	PNU	BICO
VC neu	Beschreibung neu	Beschreibung alt	VC alt	
P157	i(Err.)-Reg.Kp (MC andere Bedeutung)	i(Err.)-Reg.Kp	P146	
P158	i(Err.,mindest) (MC andere Bedeutung)	i(Err.,mindest)	P147	
P159	Glätt dl(Err) (MC andere Bedeutung)	Glätt dl(Err)	P148	
r160	lerr(soll) (MC andere Bedeutung)	lerr(soll)	r149	K0135
P161	l(Betr.,mindest) (MC andere Bedeutung)	l(Betr.,mindest)	P281	
P162	df(Umsch,CosPhi) (MC andere Bedeutung)	df(Umsch,CosPhi)	P282	
P163	Psi-Reg.Kp (MC andere Bedeutung)	Psi-Reg.Kp	P326	
P164	U(max)-Reg.Kp (MC andere Bedeutung)	U(max)-Reg.Kp	P327	
P165	EMK(max)-Reg.Kp	EMK(max)-Reg.Kp	P328	
P166	Kp Tdd	Kp Tdd	P309	
P167	Kp Tdq	Kp Tdq	P318	
r168	Lastwinkel	Lastwinkel	r325	K093
P172	Q.Lagesetzwert	Q.Anfangswinkel	P158	
r185	Lage (ist,Mot.)	Lagewinkel	r160	KK0120
r186	Rotorwinkel	Rotorwinkel	r159	KK0090
P187	T(tot,Läuf.winkel)	T(tot,Läuf.winkel)	P161	
P215	dn(ist,zulässig)	dn(ist,zulässig)	P215	
P216	Glätt n/f(Vorst)	Glätt n/f(Vorst)	P216	
P217	SchleppfKorr.	SchleppfKorr.	P217	
r218	n/f(ist) in Hz	n/f(ist)	r218	KK0148
r219	n(ist) in 1/min	n(ist)	r219	---
P221	Glätt. n/f(soll)	Glätt. n/f(soll)	P241	
P222	Q.n/f(ist)	Q.n/f(ist)	P207	
P223	Glätt. n/f(ist)	Glätt. n/f(ist)	P221	
r229	n/f(soll,glatt)	n/f(soll,Reg)	r223	KK0150
r230	n/f(ist,glatt)	n/f(ist,glatt)	r222	KK0151
P232	Q.n-Reg.Adapt.	Q.n/f-Reg.Adap.	P226	
P233	n/f-Reg.Adapt 1	n (n/f-Reg.) KL1	P137	
P234	n/f-Reg.Adapt 2	n (n/f-Reg.) KL2	P138	
P235	n/f-Reg.Kp1	n/f-Reg.Kp	P225	
P236	n/f-Reg.Kp2	Kp(n/f-Reg.) KL2	P139	
r237	n/f-Reg.Kp(ist)	n/f-Reg.Kp(ist)	r228	---
P240	n/f-Reg. Tn	n/f-Reg. Tn	P229	
P245	Q.Statik	Statik	P247	

PNU	OP1-Parametername ALLGEMEINE PARAMETER	OP1-Parametername	PNU	BICO
VC neu	Beschreibung neu	Beschreibung alt	VC alt	
P246	Scal. Statik	Statik Kp	P248	
P249	DT1-Glied T1	Glätt n-Dämpfung	P251	
P250	DT1-Glied Td	n-Dämpfung Kd	P250	
P251	Bandsperr Kp	Filter Kp	P157	
P253	FilterBandbreite	FilterBandbreite	P156	
P254	Res.Freq.Bandsp.	Filter f(Reso.)	P155	
r255	M(soll,n/f-Reg)	M(soll,Reg.-Aus)	r238	K0153
P258	Pw,max(mot)	Pw,max(mot)	P230	
P259	Pw,max(gen)	Pw,max(gen)	P233	
P268	Kp Isq(max)	Kp Isq(max)	P231	
r269	M(soll,begr.)	M(soll,sum)	r245	K0165
r272	Isq(soll,begr.)	Isq(soll)	r246	K0167
P273	Glätt Isq(soll)	Glätt Isq(soll)	P262	
P274	Isq(soll)-Grad	Isq(soll)-Grad	P232	
P278	M(statisch)	M(statisch)	P202	
P279	M(dynamisch)	M(dynamisch)	P203	
P280	Glättung I(soll)	Glättung I(soll)	P204	
r281	Isd(soll)	Isd(soll)	r206	K0179
P282	Kp Vorst Isq	Kp_vorst_isq	P252 SC	
P283	Strom-Reg.Kp	Strom-Reg.Kp	P253	
P284	Strom-Reg.Tn	Strom-Reg.Tn	P254	
P287	Glättung Ud(ist)	Glättung Ud(ist)	P302	
P288	Entkopplung Kp1	Entkopplung Kp1	P275	
P289	Entkopplung Kp2	Entkopplung Kp2	P276	
P291	FSW Psi(soll)	Psi(soll)	P183	
P293	Feldschwächfreq.	Feldschw.Frq.	P170	
P295	Wirk.grad Optim.	Min.Lastabh.Fluß	P185	
P297	Fluß-Reg.Kp	Fluß-Reg.Kp	P140	
P298	Fluß-Reg.Tn	Fluß-Reg.Tn	P141	
P301	Glätt Psi(ist)	Glätt Psi(ist)	P186	
r302	Psi(ist)	Psi(ist)	r187	K0181
P303	Glätt.Psi(soll)	Glätt.Psi(soll)	P191	
r304	Psi(soll,gesamt)	Psi(soll,gesamt)	r195	K0197
P305	Feldschw.-Reg.Ti	Feldschw.-Reg.Ti	P193	
P306 Sy	EMK(max)	EMK(max)	P239	
P307 Sy	EMK(max)-Reg.Ti	EMK(max)-Reg.Ti	P240	
r308 Sy	Psi(soll,I-Mod.)	Psi(soll,I-Mod.)	r305	K0180
r309 Sy	Psi(ist,I-Mod.)	Psi(ist,I-Mod.)	r306	K0198
P310 Sy	Psi(mod)-Reg.Kp	Psi(mod)-Reg.Kp	P319	

PNU	OP1-Parametername ALLGEMEINE PARAMETER	OP1-Parametername	PNU	BICO
VC neu	Beschreibung neu	Beschreibung alt	VC alt	
P311 Sy	Psi(mod)-Reg.Tn	Psi(mod)-Reg.Tn	P320	
P312 Sy	Kp L(sig.,U-Mod.)	Kp L(sig.,U-Mod.)	P278	
P313	f(Umsch,EMK-Mod)	f(Umsch,EMK-Mod)	P284	
P314	f(Umsch,I-Mod)	f(Umsch,I-Mod)	P285	
P315	EMK-Reg.Kp	EMK-Reg.Kp	P287	
P316	EMK-Reg.Tn	EMK-Reg.Tn	P289	
P318	Anhebung	Anhebung	P166	
P319	Anhebung Strom	Anhebung Strom	P167	
P322	FSW Zus.Anhebung	Beschl.Strom	P171	
P325	AnhebungSpannung	Anhebung Spannung	P168	
P326	Freq.Kennlinie 1 (andere Bedeutung)	Anhebeendfrq.	P169	
P330	Q.Ausw.Kennlinie	Kennlinie	P165	
P331	Imax-Regler Kp	Imax-Regler Kp	P175	
P332	Imax-Regler Tn	Imax-Regler Tn	P176	
P334	IxR-Komp.Kp	IxR-Komp.Kp	P172	
P335	Glättung Isq	Glättung Isq	P261	
P336	Schlupfkomp.Kp	Schlupfkomp.Kp	P294	
P337	Reson.Dämpfung.Kp	Reson.Dämpfung.Kp	P299, P300	
P338	Gleichtaktkomp.	Gleichtaktkomp.	P767	
P339	Pulssystem Freig.	Pulssystem Freig.	P769	
P340	Pulsfrequenz	Pulsfrequenz	P761	
P342	Max.Aussteuergrd	Max.Aussteuergrd	P763	
r343	Aussteuergrad	Aussteuergrad	r764	K0222 K0205
P344	Aussteuerreserve	Aussteuerreserve	P765	
r345	Aussteuergrenze	Aussteuergrenze	r180	K0190
r346	Max.Ausg.Spg.	Max.Ausg.Spg.	r181	K0191
P347	Ventilspg.Komp.	Ventilspg.Komp.	P768	
P348	Totzeitkomp.	Totzeitkomp.	P770	
P349	T(totzeitkomp)	T(totzeitkomp)	P766	
P352	Bezugsfrequenz	Anlagennennfreq.	P420	
P354	Bezugsdrehmoment	Anlagennenn-M	P485	
P357	Abtastzeit	Abtastzeit	P308	
P366	Ausw.Werkseinst. vgl.P970	Werkseinst.-Typ	P077	
P367	Ausw.Reg.Art	wie Steuer/Regel-Art		
P371	Selektivität	Selektivität	P395	
P372	Simulationsbetr.	Simulations-Betr.	P733	
P373	WEA	WEA	P366	
P374	WEA Wartezeit	WEA Wartezeit	P367	
P375	Erdschlußtest	Erdschlußtest	P354	
r376	Ergebnis Erdtest	Erdschl. Erg.	r358	---

PNU	OP1-Parametername ALLGEMEINE PARAMETER	OP1-Parametername	PNU	BICO
VC neu	Beschreibung neu	Beschreibung alt	VC alt	
r377	Meßabschnitt	Meßabschnitt	r333	---
P379	Umgeb.Temperatur	Umgeb.Temperatur	P359	
P380	Mot.Tmp.Warnung	Mot.Tmp.Warnung	P360	
P381	Mot.Tmp. Störung	Mot.Tmp.Störung	P361	
P382	Motorkühlung	Motorkühlung	P362	
P383	Mot.Tmp.T1	Mot.Tmp.T1	P363	
P384	MotLastgrenzen	MotLastgrenzen	P364	
P385	Q.Motortemp	Q.Motortemp	P365	
P386	R(Läuf)-TemAdapt	R(Läuf)-TemAdapt	P310	
P387	Motorreihe	Motorreihe	P311	
P388	Motorgewicht	Motorgewicht	P312	
P389	Innenlüfter	Innenlüfter	P313	
P390	K(Übertemp.)	K(Übertemp.)	P314	
P391	K(ÜTemp.,Läufer)	K(ÜTemp.,Läufer)	P317	
P392	Pv(Eisen)	Pv(Eisen)	P315	
r393	Modelltemperatur	Modelltemperatur	r316	---
P395	DC-Bremse	DC-Bremse	P372	
P396	DC-Bremsstrom	DC-Bremsstrom	P373	
P397	DC-Bremsdauer	DC-Bremsdauer	P374	
P398	DC-Br.Einsatzfrq	DC-Br.Einsatzfrq	P375	
P399	SF	SF	P799	
P401	Festsollwert 1	Festsollwert 1	P421	KK0041
P402	Festsollwert 2	Festsollwert 2	P422	KK0042
P403	Festsollwert 3	Festsollwert 3	P423	KK0043
P404	Festsollwert 4	Festsollwert 4	P424	KK0044
P425	Konf.Motorpoti	Motpot Speichrg.	P425	
P426	Startw.Motorpoti	Motpot Startfrq.	P426	
P427	Q.Mot.poti setz.	Motorpoti setzen (andere Bedeutung)	P427	
P433	Q.Zusatzsollw.1	Q.Zusatzsollw.1	P433	
P434	Skalierung ZSW 1	Zusatzsollw.1 Kp	P434	
r437	Zusatzsollwert 1	Zusatzsollwert 1	r437	KK0067
P438	Q.Zusatzsollw.2	Q.Zusatzsollw.2	P438	
P439	Skalierung ZSW 2	Zusatzsollw.2 Kp	P439	
r442	Zusatzsollwert 2	Zusatzsollwert 2	r442	KK0068
P443	Q. Hauptsollwert	Q. Hauptsollwert	P443	
P444	Skalierung HSW	Hauptsollwert Kp	P444	
P445	Grundsollwert	Grundsollwert	P445	
r447	Hauptsollwert	Hauptsollwert	r447	KK0069
P448	Tippsollwert 1	Tippfrequenz 1	P448	
P449	Tippsollwert 2	Tippfrequenz 2	P449	
r451	n/f(soll,sum1) (andere Stelle)	n/f(soll,sum1)	(r451)	KK0070
P452	n/f(max,pos.DR)	Maximalfrq.(RDF)	P452	

PNU	OP1-Parametername ALLGEMEINE PARAMETER	OP1-Parametername	PNU	BICO
VC neu	Beschreibung neu	Beschreibung alt	VC alt	
P453	n/f(max,neg.DR)	Maximalfrq.(LDF)	P453	
P455	Ausblendfrequenz	Ausblendfrequenz	P455	
P456	Ausblendband	Ausblendband	P456	
P457	Minimalfrequenz	Minimalfrequenz	P457	
r460	n/f(soll,HLG-E.)	n/f(soll,HLG-E.)	r460	KK0072
P462	Hochlaufzeit	Hochlaufzeit	P462	
P463	Einheit HL-Zeit	Einheit HL-Zeit	P463	
P464	Rücklaufzeit	Rücklaufzeit	P464	
P465	Einheit RL-Zeit	Einheit RL-Zeit	P465	
P466	AUS 3 RL-Zeit	AUS 3 RL-Zeit	P466	
P467	Schutz-HL Kp	Schutz-HL Kp	P467	
P469	Anf.Verrundung	Anf.Verrundung	P469	
P470	Endverrundung	Endverrundung	P470	
P471	Skal. M(Vorst.)	n/f-Reg.Vorst Kp	P243	
P475	HLG-Nachführung	HLG-Nachführung	P475	
P476	HLG aktiv Hys.	HLG aktiv Hys.	P476	
r480	n/f(soll,HLG-A.)	n/f(soll,HLG-A.)	r480	KK0073
r481	n/f(soll,sum2)	n/f(soll,sum2)	r481	KK0074
r482	n/f(soll)	n/f(soll)	r482	KK0075
P486	Q.M-Sollwert	Q.M-Sollwert	P486	
P487	Skal.M-Sollw.	M-Sollwert Kp	P487	
r490	M-Sollwert	M-Sollwert	r490	K0080
P492	Mgrenz 1 FSW	Mgrenz 1 FSW	P492	K0078
P493	Q.Mgrenz 1	Q.Mgrenz 1	P493	
P494	Skal.Mgrenz 1	Mgrenz 1 Kp	P494	
r496	Mgrenz 1	Mgrenz 1	r496	K0081
r497	Mmax 1	Mmax 1	r497	K0082
P498	Mgrenz 2 FSW	Mgrenz 2 FSW	P498	K0079
P499	Q.Mgrenz 2	Q.Mgrenz 2	P499	
P500	Skal.Mgrenz 2	Mgrenz 2 Kp	P500	
r502	Mgrenz 2	Mgrenz 2	r502	K0083
r503	Mmax 2	Mmax 2	r503	K0084
P505	M-Zusatz FSW	M/I-Festsollwert	P505	K0087
P506	Q.M-Zus.Sollw.	Q.M/I-Zus.Sollw.	P506	
P507	Skal M-ZusSollw	M/I-Zus.Sollw Kp	P507	
r510	M-Zusatzsollw.	M-Zusatzsollw	r510	K0086
P515	Udmax-Regler	Udmax-Regler	P377	
P516	Udmax-Reg.Dyn.	Udmax-Reg.Dyn.	P378	
P517	KIP/FLN	KIP/FLN	P379	
P518	KIP/FLN Eins.Pkt	KIP/FLN Eins.Pkt	P380	
P519	KIP/FLN Reg.Dyn.	KIP/FLN Reg.Dyn.	P381	
P520	KIP/FLN/Udmax-Reg Kp	KIP/FLN/Udmax-Reg Kp	P382	
P521	KIP/FLN/Udmax-Reg Ti	KIP/FLN/Udmax-Reg Ti	P383	

PNU	OP1-Parametername ALLGEMEINE PARAMETER	OP1-Parametername	PNU	BICO
VC neu	Beschreibung neu	Beschreibung alt	VC alt	
P522	KIP/FLN/Udmax-Reg Td	KIP/FLN/Udmax-Reg Td	P384	
P523	FLN Uadmin	FLN Uadmin	P387	
P524	FangStill	FangStill	(P368)	
P525	Fang.Suchstrom	Fang.Suchstrom	P369	
P526	Fang.Suchgeschw.	Fang.Suchgeschw.	P370	
P527	Fang Stimul	Fang Stimul	(P376)	
r528	Sync.Zustand	Sync.Zustand	r388	B297.299
P529	Sync.Start Delta f	Sync.Start Delta f	P389	
P530	Sync.Sollwinkel	Sync.Sollwinkel	P390	
P531	Sync.Fenster	Sync.Fenster	P391	
P532	Sync.Delta fmax	Sync.Delta fmax	P392	
r533	Sync.Zielfrq.	Sync.Zielfrq.	r393	K0275
P535	SIMO-Sound	SIMO-Sound	P762	
P536	n/f-Reg.Dyn(soll)	n/f-Reg.Dyn(soll)	P346	
P537	n/f-Reg.Dyn(ist)	n/f-Reg.Dyn(ist)	P347	
P538	n/f-Reg.Schw.frq	n/f-Reg.Schw.frq	P348	
r539	Testpulse Erg.	Testpulse Erg.	r344	---
r540	Tachotest Erg.	Tachotest Erg.	r345	---
r541	Motld R(Ständer)	Motld R(Ständer)	r334	---
r542	Motld R(Läufer)	Motld R(Läufer)	r335	---
r543	Motld Ventilspg.	Motld Ventilspg.	r337	---
r544	Motld Querspg.	Motld Querspg.	r338	---
r545	Motld Totzeit	Motld Totzeit	r339	---
r546	Motld X(sigma)	Motld X(sigma)	r340	---
r547	T1. Ausgleichsfkt	Zk. Ausgleichsfkt	r341	---
r550	Steuerwort 1	Steuerwort 1	r550	K0030
r551	Steuerwort 2	Steuerwort 2	r551	K0031
r552	Zustandswort 2	Zustandswort 1	r552	K0032
r553	Zustandswort 3	Zustandswort 3	r553	K0033
P554	Q.Ein/AUS 1	Q.Ein/AUS 1	P554	
P555	Q.1 AUS2(Elektr)	Q.1 AUS2(Elektr)	P555	
P556	Q.2 AUS2(Elektr)	Q.2 AUS2(Elektr)	P556	
P557	Q.3 AUS2(Elektr)	Q.3 AUS2(Elektr)	P557	
P558	Q.1 AUS3(SHalt)	Q.1 AUS3(SHalt)	P558	
P559	Q.2 AUS3(SHalt)	Q.2 AUS3(SHalt)	P559	
P560	Q.3 AUS3(SHalt)	Q.3 AUS3(SHalt)	P560	
P561	Q.WR-Freigabe	Q.WR-Freigabe	P561	
P562	Q.HLG-Freigabe	Q.HLG-Freigabe	P562	
P563	Q.kein HLG-Halt	Q.kein HLG-Halt	P563	
P564	Q.Sollw.Freigabe	Q.Sollw.Freigabe	P564	
P565	Q.1 Quittieren	Q.1 Quittieren	P565	
P566	Q.2 Quittieren	Q.2 Quittieren	P566	
P567	Q.3 Quittieren	Q.3 Quittieren	P567	

PNU	OP1-Parametername ALLGEMEINE PARAMETER	OP1-Parametername	PNU	BICO
VC neu	Beschreibung neu	Beschreibung alt	VC alt	
P568	Q.Tippen Bit 0	Q.Tippen1 EIN	P568	
P569	Q.Tippen Bit 1	Q.Tippen2 EIN	P569	
P571	Q.positive DR	Q.Rechtsdrehfeld	P571	
P572	Q.negative DR	Q.Linksdrehfeld	P572	
P573	Q.Mot.poti Höher	Q.Motpot. Höher	P573	
P574	Q.Mot.poti Tiefer	Q.Motpot. Tiefer	P574	
P575	Q.k. Störg.ext.1	Q.k. Störg.ext.1	P575	
P576	Q.FDS Bit 0	Q.SDS Bit 0	P576	
P577	Q.FDS Bit 1	Q.SDS Bit 1	P577	
P578	Q.MDS Bit 0	Q.MDS Bit 0	P578	
P579	Q.MDS Bit 1	Q.MDS Bit 1	P579	
P580	Q.FSW Bit 0	Q.FSW Bit 0	P580	
P581	Q.FSW Bit 1	Q.FSW Bit 1	P581	
P582	Q.Sync.Freigabe	Q.Sync.Freigabe	P582	
P583	Q.Fang.Freigabe	Q.Fang.Freigabe	P583	
P584	Q.Statikfreigabe	Q.Stat/T.RegFrei	P584	
P585	Q.n/f-Reg.Freig.	Q.Reglerfreigabe	P585	
P586	Q.k. Störg.ext.2	Q.k. Störg.ext.2	P586	
P587	Q.Folgeantrieb	Q.Folgeantrieb	P587	
P588	Q.k. Warng.ext.1	Q.k. Warng.ext.1	P588	
P589	Q.k. Warng.ext.2	Q.k. Warng.ext.2	P589	
P590	Q.BICO-Datensatz	Q.Grund/Reserve	P590	
P591	Q.HS-Rückmeldung	Q.HS-Rückmeldung	P591	
P600	HS-Rückmeldezeit	HS-Rückmeldezeit	P399	
P601	Q.Digitalausg.HS	Z.HS angesteuert	P612	
P602	Erregungszeit	Erregungszeit	P189	
P603	Entregungszeit	Entregungszeit	P371	
P604	Sanftanlauf	Sanftanlauf	P190	
P631	AE Offset	CU-AE Offset	P652	
P632	AE Konfiguration	CU-AE Konfig.	P650	
P634	AE-Glättung	CU-AE Glättung	P651	
P640	Q.Analogausgang	CU-AA Istwerte	P655	
P643	AA Skalierung	CU-AA Verst.	P656	
P644	AA Offset	CU-AA Offset	P657	
P690	SCI-AE Konfig.	SCI-AE Konfig.	P660	
P691	SCI-AE Glättung	SCI-AE Glättung	P661	
P692	SCI-AE Offset	SCI-AE Offset	P662	
P693	Q.SCI-Analogausg.	SCI-AA Istwerte	P664	
P694	SCI-AA Verst.	SCI-AA Verst.	P665	
P695	SCI-AA Offset	SCI-AA Offset	P666	
P696	SCB Protokoll	SCB Protokoll	P682	
r697	SCB Diagnose		r730	---
P700	SST/SCB Busadresse	SST/SCB Busadr.	P683	

PNU	OP1-Parametername ALLGEMEINE PARAMETER	OP1-Parametername	PNU	BICO
VC neu	Beschreibung neu	Beschreibung alt	VC alt	
P701	SST/SCB Baudrate	SST/SCB Baudrate	P684	
P702	SST/SCB PKW-Anzahl	SST/SCB PKW-Anz.	P685	
P703	SST/SCB PZD-Anzahl	SST/SCB PZD-Anz.	P686	
P704	SST/SCB Tlg.Ausz.	SST/SCB TLG-Ausz	P687	
P705	SCB Peererweiterg.	SCB Peererweiterg.	P689	
P706	Q.SCB Sendedaten	SCB Istwerte	P690	
P707	Q.SST1 Sendedat.	SST1 Istwerte	P680	
P708	Q.SST2 Sendedat.	SST2 Istwerte	P681	
P711	CB Parameter 1	CB Parameter 1	P696	
P712	CB Parameter 2	CB Parameter 2	P697	
P713	CB Parameter 3	CB Parameter 3	P698	
P714	CB Parameter 4	CB Parameter 4	P699	
P715	CB Parameter 5	CB Parameter 5	P700	
P716	CB Parameter 6	CB Parameter 6	P701	
P717	CB Parameter 7	CB Parameter 7	P702	
P718	CB Parameter 8	CB Parameter 8	P703	
P719	CB Parameter 9	CB Parameter 9	P704	
P720	CB Parameter 10	CB Parameter 10	P705	
P721	CB Parameter 11	CB Parameter 11	P706	
P722	CB/TB Tlg.Ausz.	CB/TB TLG-Ausz.	P695	
r732	CB/TB Diagnose	CB/TB Diagnose	r731	---
P734	Q. CB/TB Sendedat.	CB/TB Istwerte	P692	
r782	Störzeit	Störzeit	r748	---
r783	Störg. n/f(ist)	Störg. n/f(ist)	r743	---
r784	Störg. dn/dt	Störg. dn/dt	r744	---
r785	Störg. Isq(ist)	Störg. Isq(ist)	r745	---
r786	Störg. U(soll)	Störg. U(soll)	r746	---
r787	Störg. Reg.Zust.	Störg. Reg.Zust.	r747	---
P792	zul.Soll-IstAbw.	Soll-Ist-Abw Frq	P517	
P794	Soll-IstAbw.Zeit	Soll-Ist-AbwZeit	P518	
P796	Vergleichswert	Vergl.Frq.	P512	
P797	Vergleich Hyst.	Vergl.Frq.Hys.	P513	
P800	Abschaltwert	AUS-Abschaltrfq.	P514	
P801	Abschalt Zeit	AUS-Wartezeit	P516	
P804	Überdrehzahl Hys	Überdrehzahl Hys	P519	
P805	Kipp/Blck.Zeit	Kipp/Blck.Zeit	P520	
r824	Baugr.-Kompatibilität	Baugr.-Kompatibilität	r724	---
r825	Betriebsstunden	Betriebsstunden	r013	---
r826	Baugruppencode	Baugruppencode	r723	---
r827	Generier.datum	Generierungsdat.	r721	---
r828	SW-Kennung	Softwarekennung	r722	---
r829	freie Rechenzeit	Freie Rechenzeit	r725	K0248
P830	Störmaskierung	Störmaskierung	P780	

PNU	OP1-Parametername ALLGEMEINE PARAMETER	OP1-Parametername	PNU	BICO
VC neu	Beschreibung neu	Beschreibung alt	VC alt	
r832	Phasenströme	Phasenstrom 1 Phasenstrom 3	r268 r269	K0238 K0239
r833	Umr.Temp.	Umr.Temperatur	r011	K0247
P837	Testbetrieb	Testbetrieb	P781 P782	
r838	Erg.UCE/Ü/Kest	Erg.UCE/Ü/K Test	r783	---
P840	RAM-Zugr.Adr.	RAM-Zugr.Adr.	P788	
P841	RAM-Zugr.Wert	RAM-Zugr.Wert	P789	
P842	MWHRAM-Zugr.Adr.	MWHRAM-Zugr.Adr.	P790	
P843	MWHRAM-ZugrWert	MWHRAM-ZugrWert	P791	
P847	ParallelModul	ParallelModul	P784	
P848	Test Multiparall.	Test Multiparall.	P785	
r849	Status MultiParl.	Status MultiParl.	r786	---
		Spontanmeldung	P917	
P918	CB Busadresse	CB Busadresse	P918	
P927	Parametrierfreig.	Parametrierfreig.	P927	
r947	Störspeicher	Störspeicher	r947	
r949	Störwert	Störwert	r949	
r951	Störtextliste	Störtextliste	r951	
P952	Anzahl Störfälle	Anzahl Störfälle	P952	
r953	Warnparameter 1	Warnparameter 1	r953	
r954	Warnparameter 2	Warnparameter 2	r954	
r955	Warnparameter 3	Warnparameter 3	r955	
r956	Warnparameter 4	Warnparameter 4	r956	
r957	Warnparameter 5	Warnparameter 5	r957	
r958	Warnparameter 6	Warnparameter 6	r958	
r959	Warnparameter 7	Warnparameter 7	r959	
r960	Warnparameter 8	Warnparameter 8	r960	
r964	Geräteident.	Geräteident.	r964	
r965	Profilnummer	Profilnummer	r965	
r967	Steuerwort 1	Steuerwort 1	r967	
r968	Zustandswort 1	Zustandswort 1	r968	
P970	Werkseinstellung	Werkseinstellung	P970	
P971	EEPROM-Übernahme	EEPROM-Übernahme	P971	
r980	PNU-Lst. 1 vorh.	PNU-Lst. 1 vorh.	r980	
r981	PNU-Lst. 2 vorh.	PNU-Lst. 2 vorh.	r981	
r982	PNU-Lst. 3 vorh.	PNU-Lst. 3 vorh.	r982	
r983	PNU-Lst. 4 vorh.	PNU-Lst. 4 vorh.	r983	
r984	PNU-Lst. 5 vorh.	PNU-Lst. 5 vorh.	r984	
r985	PNU-Lst. 6 vorh.	PNU-Lst. 6 vorh.	r985	
r986	PNU-Lst. 7 vorh.	PNU-Lst. 7 vorh.	r986	
r987	PNU-Lst. 8 vorh.	PNU-Lst. 8 vorh.	r987	
r988	PNU-Lst. 9 vorh.	PNU-Lst. 9 vorh.	r988	
r989	PNU-Lst. 10 vorh.	PNU-Lst. 10 vorh.	r989	

PNU	OP1-Parametername ALLGEMEINE PARAMETER	OP1-Parametername	PNU	BICO
VC neu	Beschreibung neu	Beschreibung alt	VC alt	
r990	PNU-Lst. 1 geänd.	PNU-Lst. 1 geänd.	r990	
r991	PNU-Lst. 2 geänd.	PNU-Lst. 2 geänd.	r991	
r992	PNU-Lst. 3 geänd.	PNU-Lst. 3 geänd.	r992	

10.3 Converting CUVC binectors to CU2 parameters

PNU	OP1-Parametername	OP1-Parametername	PNU
VC neu	Beschreibung neu	Beschreibung alt	VC alt
B0100	Einschaltbereit	Z.Einschaltbereit	P600
B0101	n.Einsch.Bereit	Z.Einschaltbereit	P600
B0102	Betriebsbereit	Z.Betriebsbereit	P601
B0103	n.Betriebsber.	Z.Betriebsbereit	P601
B0104	Betrieb	Z.Betrieb	P602
B0105	kein Betrieb	Z.Betrieb	P602
B0106	Störung	Z.Störung	P603
B0107	keine Störung	Z.Störung	P603
B0108	kein AUS2	Z.kein AUS2	P604
B0109	AUS2	Z.kein AUS2	P604
B0110	kein AUS3	Z.kein AUS3	P605
B0111	AUS3	Z.kein AUS3	P605
B0112	Einschaltsperr	Z.Einschaltsperr	P606
B0113	k.Einsch.Sperre	Z.Einschaltsperr	P606
B0114	Warnung	Z.Warnung	P607
B0115	kein Warnung	Z.Warnung	P607
B0116	k.Soll-IstAbw.	Z.k. Soll-Ist-Abw.	P608
B0117	Soll-IstAbw.	Z.k. Soll-Ist-Abw.	P608
B0120	VerglWert err.	Z.Vergl.Frq.err.	P610
B0121	VerglWert n.err.	Z.Vergl.Frq.err.	P610
B0122	Unterspannung	Z.Unterspannung	P611
B0123	keine Unterspg.	Z.Unterspannung	P611
B0124	HS ansteuern	Z.HS angesteuert	P612
B0125	HS n. ansteuern	Z.HS angesteuert	P612
B0126	HLG aktiv	Z.HLG aktiv	P613
B0127	HLG nicht aktiv	Z.HLG aktiv	P613
B0128	DrehzSollw.pos.	Z.Rechtsdrehfeld	P614
B0129	DrehzSollw.neg.	Z.Rechtsdrehfeld	P614
B0130	KIP/FLN aktiv	Z.KIP/FLN aktiv	P615
B0131	KIP/FLN n. aktiv	Z.KIP/FLN aktiv	P615
B0132	Fang/Err.akt.	Z.Fangen aktiv	P616
B0133	Fang/Err.n.akt.	Z.Fangen aktiv	P616
B0134	Sync. erreicht	Z.Sync. erreicht	P617
B0135	Sync. n.erreicht	Z.Sync. erreicht	P617
B0136	Überdrehzahl	Z.k. Überdrehz.	P618
B0137	k. Überdrehzahl	Z.k. Überdrehz.	P618
B0138	Störung ext.1	Z.Störg. ext 1	P619
B0139	k.Störung ext.1	Z.Störg. ext 1	P619
B0140	Störung ext.2	Z.Störg. ext 2	P620
B0141	k.Störung ext.2	Z.Störg. ext 2	P620

PNU	OP1-Parametername	OP1-Parametername	PNU
VC neu	Beschreibung neu	Beschreibung alt	VC alt
B0142	Warnung ext.	Z.Warnung. ext.	P621
B0143	k. Warnung ext.	Z.Warnung. ext.	P621
B0144	WarngÜLast Umr.	Z.Warnung. i2tUmr	P622
B0145	k.WarngÜLastUmr	Z.Warnung. i2tUmr	P622
B0146	StörgÜTemp Umr.	Z.Störg. ÜTmUmr	P623
B0147	k.StörgÜTempUmr	Z.Störg. ÜTmUmr	P623
B0148	Warng Ütemp Umr.	Z.Warnung. ÜTmUmr	P624
B0149	k.WarngÜTempUmr	Z.Warnung. ÜTmUmr	P624
B0150	Warng Ütemp Mot.	Z.Warnung. ÜTmMot	P625
B0151	k.WarngÜTempMot.	Z.Warnung. ÜTmMot	P625
B0152	Störg ÜTemp Mot.	Z.Störg. ÜTmMot	P626
B0153	k.StörgÜTempMot	Z.Störg. ÜTmMot	P626
B0156	Motor gekippt	Z.Mot. Kipp/Blck	P628
B0157	Motor n.gekippt	Z.Mot. Kipp/Blck	P628
B0158	ÜS geschlossen	Z.ÜS angesteuert	P629
B0159	ÜS n.geschloss.	Z.ÜS angesteuert	P629
B0160	Sync.Fehler	Z.Sync.Fehler	P630
B0161	k. Sync.Feher	Z.Sync.Fehler	P630
B0162	Vorladung aktiv	Z.Vorladg. aktiv	P631
B0163	Vorladung n.akt.	Z.Vorladg. aktiv	P631
B0205	HLG gesperrt	HLG Zustand	r461
B0206	HLG freigegeben	HLG Zustand	r461
B0207	HLG angehalten	HLG Zustand	r461
B0208	HLG gesetzt	HLG Zustand	r461
B0209	HLG nachgeführt	HLG Zustand	r461
B0229	Setz.I-Ant.akt.	Regelungszustand	r150
B0231	M(grenz,1)akt.	Regelungszustand	r150
B0232	M(grenz,2)akt.	Regelungszustand	r150
B0235	Isq(max) red.	Regelungszustand	r150
B0236	I(max)-Reg. akt.	Regelungszustand	r150
B0237	HLG-Setzen	Regelungszustand	r150
B0238	HLG-HL-Sperre	Regelungszustand	r150
B0239	HLG-RL-Sperre	Regelungszustand	r150
B0240	Schutz-HLG akt.	Regelungszustand	r150
B0251	Feldschwächung	Regelungszustand	r150
B0252	EMK-Reg.in Begr.	Regelungszustand	r150
B0253	EMK-Modell akt.	Motormodell	r286
B0254	f(soll) in Begr.	Regelungszustand	r150
B0295	Ud(min)-Reg.akt.	Regelungszustand	r150
B0296	Ud(max)-Reg.akt.	Regelungszustand	r150
B0297	Synchron. aus	Sync. Zustand	r388
B0298	Sync.Freq.messg.	Sync. Zustand	r388
B0299	Sync.Phasenmess.	Sync. Zustand	r388

PNU	OP1-Parametername	OP1-Parametername	PNU
VC neu	Beschreibung neu	Beschreibung alt	VC alt
B0320	RZM / FLM	Steuersatzzust.	r760
B0321	asyn/syn.Systeme	Steuersatzzust.	r760
B0322	Übersteuerung	Steuersatzzust.	r760
B0323	FLM Systemnr.1	Steuersatzzust.	r760
B0324	FLM Systemnr.2	Steuersatzzust.	r760
B0325	FLM Systemnr.3	Steuersatzzust.	r760
B0326	FLM Systemnr.4	Steuersatzzust.	r760

10.4 Converting CUVC connectors to CU2 parameters

PNU	OP1-Parametername	OP1-Parametername	PNU
VC neu	Beschreibung neu	Beschreibung alt	VC alt
KK0020	Drehzahl (geglättet)	Drehzahl	r002
K0021	Ausgangsspannung (geglättet)	Ausgangsspannung	r003
K0022	Ausgangsstrom (geglättet)	Ausgangsstrom	r004
K0023	Ausgangsleistung (geglättet)	Ausgangsleistung	r005
K0024	Drehmoment (geglättet)	Drehmoment	r007
K0025	Zwischenkreisspannung (geglättet)	Zwischenkreisspannung	r006
K0030	Steuerwort 1	Steuerwort 1	r550
K0031	Steuerwort 2	Steuerwort 2	r551
K0032	Zustandswort 1	Zustandswort 1	r552
K0033	Zustandswort 2	Zustandswort 2	r553
KK0041	Festsollwert	Festsollwert 1	P0421
KK0042	Festsollwert	Festsollwert 2	P0422
KK0043	Festsollwert	Festsollwert 3	P0423
KK0044	Festsollwert	Festsollwert 4	P0424
KK0067	Zusatzsollwert 1	Zusatzsollwert 1	r437
KK0068	Zusatzsollwert 2	Zusatzsollwert 2	r442
KK0069	Hauptsollwert	Hauptsollwert	r447
KK0070	n/f(soll,sum1)	n/f(soll,sum1)	r451
KK0072	n/f(soll,HLG-E)	n/f(soll,HLG-E)	r460
KK0073	n/f(soll,HLG-A)	n/f(soll,HLG-A)	r480
KK0074	n/f(soll,sum2)	n/f(soll,sum2)	r481
KK0075	n/f(soll,begr)	n/f(soll)	r482
K0077	M(Beschl.)	M(soll,zusatz)	(r244)
K0080	M-Sollwert	M-Sollwert	r490
K0081	Mgrenz 1	Mgrenz 1	r496
K0082	Mmax 1	Mmax 1	r497
K0083	Mgrenz 2	Mgrenz 2	r502
K0084	Mmax 2	Mmax 2	r503
K0086	M-Zusatzsollw.	M/I-Zusatzsollw.	r510
K0087	M-Zusatz FSW	M/I-Festsollwert	P505
K0090	Rotorwinkel		r159
KK0091	n/f(ist,Geber)		r214
K0092	Flußwinkel-Diff.		r162
K0093	Lastwinkel		r325
KK0120	Lagewinkel		r160
KK0148	n/f(ist)	n/f(ist)	r218
KK0149	n/f(Vorst)	n/f(Vorst)	r220
KK0150	n/f(soll,glatt)	f/f(soll,Reg)	r223
KK0151	n/f(ist,glatt)	n/f(ist,glatt)	r222
KK0152	n/f(Regeldiff.)	n/f-Regeldiff	r224
K0153	M(soll,n/f-Reg.)	M(soll,Reg.-Aus)	r238

PNU	OP1-Parametername	OP1-Parametername	PNU
VC neu	Beschreibung neu	Beschreibung alt	VC alt
K0155	n/f(Reg,I-Ant.)	M(n/f-Reg,i)	r237
KK0157	n/f(Statik) (andere Stelle)	n/f(Statik)	r249
K0159	Ausg.DT1-Glied	disq-Dämpfung	r252
K0164	M(soll,vorst.)	M(soll,zusatz)	r244
K0165	M(soll,begr.)	M(soll,sum)	r245
K0167	Isq(begr)	Isq(soll)	r246
K0168	Isq(soll,akt)	Isq(soll,glatt)	r263
K0172	M(grenz1,ist)	Mmax(n-Reg.)	r235
K0173	M(grenz2,ist)	Mmin(n/f-Reg.)	r236
K0175	I(max,zulässig)	Imax(soll)	r174
K0176	Isq(max,abs.)	Isqmax	r234
K0177	Isd(statisch)	Isd(statisch)	r201
K0178	I(soll,glatt)	I(soll,glatt)	r205
K0179	Isd(soll)	Isd(soll)	r206
K0180	Psi(soll)	Psi(soll,I-Mod.)	r305
K0181	Psi(ist)	Psi(ist)	r187
K0182	Isd(ist)	Isd(ist)	r256
K0183	Isd(soll,akt.)	Isd(soll,glatt)	r255
K0184	Isq(ist)	Isq(ist)	r264
KK0188	f(Schlupf)	Schlupffrequenz	r296
K0189	U(soll,abs) (ungeglättet, begrenzt)	Ausgangsspannung	(r003)
K0190	Aussteuergrenze	Aussteuergrenze	r180
K0191	Max.Ausg.Spg.	Max.Ausg.Spg.	r181
KK0192	Feldschw.Frq(ist)	FeldschwFrq(ist)	r182
K0193	Psi(Kennlinie)	Psi(Kennlinie)	r184
K0194	Psi(Lastabhänig)	Psi(lastabh.)	r188
K0195	Psi(soll,glatt)	Psi(soll,glatt)	r192
K0196	Psi(FeldschwReg)	Psi(FeldschwReg)	r194
K0197	Psi(soll,gesamt)	Psi(soll,gesamt)	r195
K0198	Kp Tdd	Kp Tdd	r309
K0199	f(soll,Ständer)	f(soll,Ständer)	r297
KK0200	f(soll,Steuersatz)	f(soll,Steuers.)	r298
K0204	U(soll,U/f) (ungeglättet,begrenzt)	Ausgangsspannung	r003
K0205	A(soll,U/f)	Aussteuergrad	r764
K0208	I _{max} -Reg.(Ausg.) (f)	f(I _{max} -Reg.)	r177
K0209	I _{max} -Reg.(Ausg.) (U)	U(I _{max} -Reg.)	r178
K0210	I _{err} (soll)	I _{err} (soll)	r149
K0211	I _{err} (ist)	I _{err} (ist)	r145
K0212	dI _{err} (sd)	dI _{err} (sd)	r142
K0213	I _{μd} (I-Mod.-Reg.)	I _{μd} (I-Mod.-Reg.)	r321
K0214	I _{μd} (I-Mod-Reg,i)	I _{μd} (I-Mod-Reg,i)	r322
K0215	I _{μd} (soll,I-Mod.)	I _{μd} (soll,I-Mod.)	r323
K0216	I _{μq} (soll,I-Mod.)	I _{μq} (soll,I-Mod.)	r324

PNU	OP1-Parametername	OP1-Parametername	PNU
VC neu	Beschreibung neu	Beschreibung alt	VC alt
K0217	Umax(Isd-Reg.)	Umax(Isd-Reg.)	r257
K0218	Usd(Isd-Reg.)	Usd(Isd-Reg.)	r258
K0219	Usd(Isd-Reg.,i)	Usd(Isd-Reg.,i)	r259
K0220	Usq(Isq-Reg.)	Usq(Isq-Reg.)	r265
K0221	Usq(Isq-Reg.,i)	Usq(Isq-Reg.,i)	r266
K0222	Aussteuergrad	Aussteuergrad	r764
K0227	dIsd(soll,P-Reg)	dIsd(soll,P-Reg)	r329
K0228	Usd(Entkoppl.)	Usd(Entkoppl.)	r277
K0229	Alpha(soll)	Alpha(soll)	r280
K0230	EMK-Reg. Kp(ist)	EMK-Reg. Kp(ist)	r288
K0231	EMKsd	EMKsd	r293
KK0232	fmax(EMK-Reg.)	fmax(EMK-Reg.)	r290
KK0233	f(EMK-Reg.,p)	f(EMK-Reg.,p)	r291
KK0234	f(EMK-Reg.,i)	f(EMK-Reg.,i)	r292
KK0235	f(Reson.Dämpfg)	f(Reson.Dämpfg)	r301
K0236	Ud(ist,glatt)	Ud(ist,glatt)	r304
K0238	Phasenstrom1	Phasenstrom1	r268
K0239	Phasenstrom3	Phasenstrom3	r269
K0240	Uzk(ist) (ungeglättet)	Ud(ist)	r303
K0241	M(ist) (ungeglättet)	Drehmoment	(r007)
K0242	I(Ausg.Betrag) (ungeglättet)	I Ausg. (Betrag)	r179
K0244	Motorauslastung	Motorauslastung	r008
K0245	Motortemperatur	Motortemperatur	r009
K0247	Umr.Temperatur	Umr.Temperatur	r011
K0248	freie Rechenzeit	freie Rechenzeit	r725
K0249	Umrichterzustand	Umrichterzustand	r001
K0270	f(KIP/UdmaxReg))	f(KIP/FLN/UdmaxReg))	r385
K0271	I(KIP/UdmaxReg)	I(KIP/FLN/UdmaxReg)	r386
KK0275	Sync.Zielfrq.	Sync.Zielfrq.	r393
K0276	Sync.Phasendiff	Sync.Phasendiff	r394

11 Faults and Alarms

Faults

General information regarding faults

For each fault, the following information is available:

Parameter	r947	Fault number
	r949	Fault value
	r951	Fault list
	P952	Number of faults
	r782	Fault time

If a fault message is not reset before the electronic supply voltage is switched off, then the fault message will be present again when the electronic supply is switched on again. The unit cannot be operated without resetting the fault message. (Exception: Automatic restart has been selected, see P373).

Fault number	Fault	Counter-measure
F001	<p>Main contactor checkback</p> <p>If a main contactor checkback is configured, no checkback takes place within the time set in P600 after the power-up command.</p> <p>In the case of externally excited synchronous motors (P095 = 12), there is no checkback for the excitation current unit.</p>	<p>P591 Src Contactor Msg</p> <p>Parameter value must be in conformance with the connection of the main contactor checkback.</p> <p>Check the checkback loop of the main contactor (or the checkback of the excitation current unit in the case of synchronous motors).</p>
F002	<p>Pre-charging</p> <p>When pre-charging, the minimum DC link voltage (P071 Line Volts ### 1.34) of 80 % has not been reached.</p> <p>The maximum pre-charging time of 3 seconds has been exceeded.</p>	<p>Check the supply voltage,</p> <p>Compare with P071 Line Volts (compare P071 with the DC link voltage on DC units).</p> <p>Check the rectifier/regenerative unit on DC units. The rectifier/regenerative unit must be switched on before the inverter is switched on.</p>

Fault number	Fault	Counter-measure																														
<p>F006</p>	<p>DC link overvoltage Shutdown has occurred due to excessive DC link voltage.</p> <table border="0"> <tr> <td><u>Line voltage</u></td> <td> </td> <td><u>DC voltage</u></td> <td> </td> <td><u>Shutdown</u></td> </tr> <tr> <td></td> <td></td> <td><u>range</u></td> <td></td> <td><u>threshold</u></td> </tr> <tr> <td>208 V - 230 V</td> <td> </td> <td>280 V – 310 V</td> <td> </td> <td>appr. 410 V</td> </tr> <tr> <td>380 V - 460 V</td> <td> </td> <td>510 V – 620 V</td> <td> </td> <td>appr. 820 V</td> </tr> <tr> <td>500 V - 575 V</td> <td> </td> <td>675 V – 780 V</td> <td> </td> <td>appr. 1020 V</td> </tr> <tr> <td>660 V - 690 V</td> <td> </td> <td>890 V – 930 V</td> <td> </td> <td>appr. 1220 V</td> </tr> </table> <p>For parallel-connected converters (BF L) r949 = 1: Overvoltage in the DC link of the master r949 = 2: Overvoltage in the DC link of the slave.</p>	<u>Line voltage</u>		<u>DC voltage</u>		<u>Shutdown</u>			<u>range</u>		<u>threshold</u>	208 V - 230 V		280 V – 310 V		appr. 410 V	380 V - 460 V		510 V – 620 V		appr. 820 V	500 V - 575 V		675 V – 780 V		appr. 1020 V	660 V - 690 V		890 V – 930 V		appr. 1220 V	<p>Check the supply voltage or input DC voltage. Converter is operating in regenerative mode without rectifier possibility. If the converter supply voltage is at the upper tolerance limit and it is operating at full load, F006 can also be caused by a line phase failure.</p> <p>Possibly:</p> <ul style="list-style-type: none"> • Increase P464 Decel Time, • Activate P515 DC Bus Volts Reg (check P071 beforehand) • Reduce P526 Fly Search Speed. • Reduce P259 Max Regen Power (only for P100 = 3, 4 or 5)
<u>Line voltage</u>		<u>DC voltage</u>		<u>Shutdown</u>																												
		<u>range</u>		<u>threshold</u>																												
208 V - 230 V		280 V – 310 V		appr. 410 V																												
380 V - 460 V		510 V – 620 V		appr. 820 V																												
500 V - 575 V		675 V – 780 V		appr. 1020 V																												
660 V - 690 V		890 V – 930 V		appr. 1220 V																												
<p>F008</p>	<p>DC link undervoltage The lower limit value of 76 % of the DC link voltage (P071 Line Volts), or of 61 % when kinetic buffering has been enabled, has been fallen short of. Undervoltage in the DC link in 'normal' operation (i.e. no SIMULATION). Undervoltage in the DC link with active kinetic buffering and speed less than 10 % of the rated motor speed. It was a 'brief power failure' which was not detected until system recovery (auto restart flag).</p>	<p>Check:</p> <ul style="list-style-type: none"> • Input DC voltage • DC link 																														
<p>F011</p>	<p>Overcurrent Overcurrent shutdown has occurred. The shutdown threshold has been exceeded.</p>	<p>Check</p> <ul style="list-style-type: none"> • the converter output for short-circuit or ground fault • the load for an overload condition • whether motor and converter are correctly matched • whether the dynamic requirements are too high. 																														
<p>F012</p>	<p>I too low During excitation of the induction motor, the current did not rise above 12.5 % of the setpoint magnetizing current for no-load operation.</p>	<p>Only for closed loop n/f/T control (P100 = 3, 4 or 5) If no motor is connected, go into the simulation mode P372. Check current detection, check power section.</p>																														

Fault number	Fault	Counter-measure
<p>F015</p>	<p>Motor stall Motor has stalled or is locked:</p> <ul style="list-style-type: none"> • if the static load is too high • if the acceleration or deceleration time is too fast or if load change is too fast and too great, • due to incorrect parameterization of the pulse encoder pulse number P151 or of the analog tachometer scaling P138. • due to disturbed speed signals (tachometer shield not connected) <p>The fault is only generated after the time set in P805.</p> <p>The binector B0156 is set, in the status word 2 r553 Bit28.</p> <p>To detect whether the drive is locked, see P792 (Perm Deviation) and P794. With n/f control, this fault is tripped if the torque limits have been reached (B0234).</p> <p>With speed control (P100 = 4) and master drive (see P587), the fault can also point to an interruption in the encoder cable. This case has the same significance as if the drive is locked.</p> <p>With v/f control, the I(max) controller has to be activated (P331). The monitor does not operate with v/f textile applications (P100 = 2).</p> <p>Motor has stalled or is locked:</p> <ul style="list-style-type: none"> • By reaching the maximum frequency in the case of synchronous motors (P095 = 12,13) <p>As a result of missing or excessively high excitation current in the case of externally excited synchronous motors (P095 = 12): (flux is too small or too great).</p> <p>When the maximum frequency (including control reserves) (B0254) has been reached on synchronous motors, the fault is generated immediately. If the deviations in the rotor flux are too great, first of all, the converter current is switched to zero, the excitation current is reduced and, after some time, the fault message is tripped at the level of the double damping time constant (2*r124.1). During this wait time, the status word bit is set already B0156 (r553.28)</p>	<ul style="list-style-type: none"> • Reduce load • Release brake • Increase current limits • Increase P805 PullOut/BlckTime • Increase P792 response threshold for set/actual deviation <p>Only for f/n/T control (P100 = 3, 4, 5)</p> <ul style="list-style-type: none"> • Increase torque limits or torque setpoint <p>Only n/T control or v/f control with speed controller: (P100 = 0, 4, 5)</p> <ul style="list-style-type: none"> • Check tachometer cable breal • Check pulse encoder pulse number • Check analog tachometer scaling • Connect shield of tachometer cable on motor side and converter side • Reduce smoothing of speed pre-control P216 (only n/T control) <p>Only frequency control: (P100 = 3)</p> <ul style="list-style-type: none"> • Slow down acceleration time (see also P467-ProtRampGen Gain) • Increase current in the lower frequency range (P278, P279, P280) • Switch in speed controller pre-control (P471>0) • Set EMF controller more dynamically (P315) to max. approx. 2 • Increase changeover frequency for the EMF model (P313) • Replace by speed control with pulse encoder <p>In the case of overmodulated n/f controller:</p> <ul style="list-style-type: none"> • Track speed setpoint with the speed actual value so that the set/actual deviation is always less than that set in P792. <p>Only for synchronous motor: (P095 = 12)</p> <ul style="list-style-type: none"> • Check current limits of the excitation unit. • Check excitation current setpoint and actual value (incl. wiring) • Check voltage limits of the excitation unit during dynamic current changes. • Check drive system for resonance oscillations.

Fault number	Fault	Counter-measure
F017	SAFE OFF in operation	Check whether the switch for SAFE OFF (X009/5-6) is open (only for devices with Order No....-11, ...-21,...-31).
F018	F set fly The found set-frequency could not be implemented because the additional setpoint is too high.	Check additional setpoint. Power up after coasting. Release both directions of rotation.
F019	Motor not found Motor has not been found (during flying restart without tachometer).	Power up after coasting. Possibly increase P525 Fly Search Amps.
F020	Motor temperature The motor temperature limit value has been exceeded. r949 = 1 Limit value of motor temperature exceeded r949 = 2 Short-circuit in the cable to the motor temperature sensor or sensor defective r949 = 3 wire break in the cable to the motor temperature sensor or sensor defective	Check the motor (load, ventilation, etc.). The actual motor temperature can be read in r009. Check P381 Mot Tmp Fault Check the KTY84 input at connector X103:29,30 for short-circuit.
F021	Motor I2t Parameterizable limit value of the I2t monitoring for the motor has been exceeded.	Check: P383 Mot Tmp T1
F023	Inverter temperature The limit value of the inverter temperature has been exceeded. r949 = 1: Limit value of inverter temperature has been exceeded. r949 = 2: Sensor 1: Wire break of sensor cable or sensor defective r949 = 18: Sensor 2: Wire break of sensor cable or sensor defective r949 = 34: Sensor 3: Wire break of sensor cable or sensor defective r949 = 50: Sensor 4: Wire break of sensor cable or sensor defective	Measure the air intake and ambient temperature. Please observe the reduction curves at ### >40 °C. Check: <ul style="list-style-type: none"> • Whether the fan -E1 is connected and is rotating in the correct direction. • That the air entry and discharge openings are not restricted. • Temperature sensor at -X30
F025	UCE Ph. L1 There has been an UCE shutdown in phase L1.	Check: <ul style="list-style-type: none"> • Phase L1 for short-circuit or ground fault (-X2:U2 – including motor). • That CU is correctly inserted. • That the switch for 'SAFE OFF' (X9/5-6) is open (only for units with Order No. ...-11, ...-21,...-31).

Fault number	Fault	Counter-measure
F026	UCE Ph. L2 There has been an UCE shutdown in phase L2.	Check: <ul style="list-style-type: none"> • Phase L2 for short-circuit or ground fault (-X2:V2 – including motor). • That CU is correctly inserted. • That the switch for 'SAFE OFF' (X9/5-6) is open (only for units with Order No. ...-11, ...-21,...-31).
F027	UCE Ph. L3 There has been an UCE shutdown in phase L3.	Check : <ul style="list-style-type: none"> • Phase L3 for short-circuit or ground fault (-X2:W2 – including motor). • That CU is correctly inserted. • That the switch for 'SAFE OFF' (X9/5-6) is open (only for units with Order No. ...-11, ...-21,...-31).
F028	Supply phase The frequency and the amplitude of the DC link ripple indicate a single-phase power failure.	Check the supply voltage.
F029	Meas. value sensing A fault has occurred in the measured value sensing system; <ul style="list-style-type: none"> • (r949 = 1) Offset adjustment not possible in phase L1 • (r949 = 2) Offset adjustment not possible in phase L3 • (r949 = 3) Offset adjustment not possible in phases L1 and L3 • (r949=65) Autom. Adjustment of the analog inputs is not possible 	Fault in measured value sensing. Fault in power section (valve cannot block) Fault on CU
F035	Ext. fault 1 Parameterizable external fault input 1 has been activated	Check: <ul style="list-style-type: none"> • whether there is an external fault • whether the cable to the appropriate digital input has been interrupted • P575 Src No ExtFault1
F036	Ext. fault 2 Parameterizable external fault input 2 has been activated	Check: <ul style="list-style-type: none"> • Whether there is an external fault • Whether the cable to the appropriate digital input has been interrupted • P586 Src No ExtFault2

Fault number	Fault	Counter-measure
F037	Analog input	Check the connection to <ul style="list-style-type: none"> • Analog input 1 -X102:15, 16. • Analog input 2 -X102: 17, 18. Check parameters <ul style="list-style-type: none"> • P632 CU Analn Conf • P634 CU Analn Smooth • P631 CU Analn Offset
F038	Voltage OFF during parameter storage During a parameter task, a voltage failure occurred on the board.	Re-enter the parameter. The number of the parameter concerned can be seen in fault value r949.
F040	AS internal Incorrect operating status	Replace CU (-A10)
F041	EEPROM fault A fault has occurred when storing the values in the EEPROM.	Replace CU (-A10)
F042	Calculating time Calculating time problems	Reduce the calculating time load: <ul style="list-style-type: none"> • Increase P357 Sampling Time • Calculate individual blocks in a slower sampling time Observe r829 CalcTimeHdroom.
F044	BICO Manager	
F045	Opt. Board HW A hardware fault has occurred when accessing an optional board.	Replace CU Check connection of the board subrack to the boards
F046	Par. Task	Power the unit down and up again. Replace CU (-A10).
F047	Internal calculating time The calculating time in the gating unit computer is not sufficient.	Replace CU (-A10). For synchronous motors (P095 = 12): Pulse frequency is set too high (P340 > 2kHz).
F048	Internal pulse frequency	Change P340 Pulse Frequency.
F049	SW Version The firmware versions on the CU have a different firmware release.	Use uniform firmware
F050	TSY Init. Error when initializing the TSY board	Check: <ul style="list-style-type: none"> • Whether the TSY is correctly inserted

Fault number	Fault	Counter-measure
F051	Speed encoder Digital tachometer or analog tachometer sensing are faulty.	Check the parameters: <ul style="list-style-type: none"> • P130 Src SpdActV • P151 • P138 AnalogTachScale • P109 Motor #PolePairs The product of P109 and P138 must be smaller than 19200. Check or replace tachometer. Check connection to tachometer. Replace CU
F052	n-Cntr. Input The fault input on the TSY has been active.	Cancel tachometer with control track P130 Src Spd ActV Replace TSY. Check the tachometer connection at the TSY. Several versions are possible, depending on the type of tachometer.
F053	Tachometer dn/dt The permissible change value of the speed encoder signal P215 dn(act,perm) has been doubly exceeded.	Check tachometer cables for interruptions. Check earthing of tachometer shield. <ul style="list-style-type: none"> • The shield must be connected both at the motor and the converter side. • The encoder cable must not be interrupted. • The encoder cable must not be laid together with the power cables. • Only recommended encoders should be used. • In the case of a signal fault, the DT1 board may have to be used. If necessary, change P215
F054	Sensor board initialization fault	Fault value r949 1: Board code incorrect 2: TSY not compatible 20: TSY board double
F056	SIMOLINK telegram failure	Check: <ul style="list-style-type: none"> • Fiber-optic cable ring • Whether an SLB in the ring is without voltage • Whether an SLB in the ring is faulty • Check P741 (SLB TIg OFF)
F058	Parameter error during parameter task	No counter-measure

Fault number	Fault	Counter-measure
F059	Parameter error after factory setting/initialization	The number of the inconsistent parameter is indicated in fault value r949. Correct this parameter (ALL indices) and power down and power up the voltage again. Depending on circumstances, several parameters may be concerned, i.e. repeat the procedure.
F060	MLFB is missing This is set if the MLFB = 0 after exiting INITIALIZATION (0.0 kW). MLFB = order number.	After acknowledgement, in INITIALIZATION enter a suitable MLFB in parameter P070 MLFB (6SE70..). (Only possible with the corresponding access stages to both access parameters).
F061	Incorrect parameterization A parameter entered during drive setting (e.g. P107 Mot Rtd Freq, P108 Mot Rtd Speed, P340 Pulse Frequency) is not in a permissible range (depending on control type)	Acknowledge the fault and change the corresponding parameter value. The missing parameter is indicated in r949 as a fault value.

Fault number	Fault	Counter-measure
<p>F062</p>	<p>Multi-parallel circuit Fault in connection with the multi-parallel circuit or board ImP1 has been detected.</p>	<p>r949 = 10: Communications card does not reply. When writing the control word, BUSY is not active if CSOUT is inactive. Communications card is probably not inserted.</p> <p>r949 = 11,12: Timeout during BUSY during initialization. BUSY does not become active within 1 sec.</p> <p>r949 = 15: Timeout during BUSY during normal communication. BUSY does not become active within 1 sec.</p> <p>r949 = 18: Timeout when reading out the fault information from the ImPIs. Within one second after activation of FAULT no fault cause can be supplied by the ImP1.</p> <p>r949 = 20+i: HW conflict. This is set if bit HWCONF is set in status word of slave i. (Fault in the configuration of the multi-parallel circuit)</p> <p>r949 = 30+i: HW version of ImPI is not compatible. The relevant slave number is contained in i.</p> <p>r949 = 40: Number of slaves does not tally with the setpoint number of slaves of the unit.</p> <p>r949 = 50+i: Inconsistency in the number of slaves. The number of slaves notified by the ImPI is not in conformance with the number of status words or with the setpoint number of slaves of the MLFB.</p> <p>Counter-measure:</p> <ul style="list-style-type: none"> • Check ImPI or communications card and replace, if necessary. • Check configuration of multi-parallel circuit. • Check parameterization. • Replace CU. • Replace ImPI.
<p>F065</p>	<p>SCom Telegram No telegram was received at an SCom interface (SCom/USS protocol) within the telegram failure time.</p>	<p>r949 = 1 SCom1 r949 = 2 SCom2</p> <ul style="list-style-type: none"> • Check the connection CU -X100:1 to 5 and check the connection PMU -X300. • Check "Scom/SCB TLG OFF" P704.01 (SCom1) and P704.02 (SCom2) • Replace CU (-A10).



Fault number	Fault	Counter-measure
F070	SCB Init. Error during initialization of the SCB	r949 = 1: Board code incorrect r949 = 2: SCB board not compatible r949 = 5: Initialization data error <ul style="list-style-type: none"> • Check parameter SCB Protocol P696 parameter and Scom/SCB Baud Rate P701.03 r949 = 6: Timeout during initialization r949 = 7: SCB board double r949 = 10: Error in configuration channel
F072	EB initialization error	r949 = 2: 1. EB1 not compatible r949 = 3: 2. EB1 not compatible r949 = 4: 1. EB2 not compatible r949 = 5: 2. EB2 not compatible r949 = 21: There are three EB1 boards r949 = 22: There are three EB2 boards
F073	Analn1 SL1 4 mA at analog input 1, slave1 fallen short of	Check the connection between the signal source and the SCI1 (Slave 1) -X428:4, 5.
F074	Analn2 SL1 4 mA at analog input 2, slave1 fallen short of	Check the connection between the signal source and the SCI1 (Slave 2) -X428:7, 8.
F075	Analn3 SL1 4 mA at analog input 3, slave1 fallen short of	Check the connection between the signal source and the SCI1 (Slave 3) -X428:10, 11.
F076	Analn1 SL2 4 mA at analog input 1, slave2 fallen short of	Check the connection between the signal source and the SCI1 (Slave1) -X428:4, 5.
F077	Analn2 SL2 4 mA at analog input 2, slave2 fallen short of	Check connection between signal source and SCI1 (Slave 2) -X428:7,8.
F078	Analn3 SL2 4 mA at analog input 3, slave2 fallen short of	Check connection between signal source and SCI1 (Slave 3) -X428:10, 11.
F079	SCB Telegram No telegram has been received by the SCB (USS, Peer-to-Peer, SCI) within the telegram failure time.	<ul style="list-style-type: none"> • Check connection of SCB1(2). • Check P704.03"SCom/SCB TLG OFF". • Replace SCB1(2). • Replace CU (-A10).

Fault number	Fault	Counter-measure
F080	TB/CB Init. Error during initialization of the board at the DPR interface	r949 = 1: TB/CB not inserted or TB/CB board code incorrect r949 = 2 TB not compatible r949 = 3: CB not compatible r949 = 5: Error in initialization data Check that the T300 / CB board is inserted correctly r949 = 6: Timeout during initialization r949 = 7: TB/CB board double r949 = 10: Error in configuration channel Check the CB initialization parameter: <ul style="list-style-type: none"> • P918 CB Bus Address • P711 to P721 CB parameters 1 to 11
F081	Opt. Board Heartb TB, CB or SCB no longer processes the monitoring counter	r949 = 0: TB/CB Heartbeat counter r949 = 1: SCB Heartbeat counter <ul style="list-style-type: none"> • Replace SCB, TB or CB • Check connection between subrack and optional boards
F082	TB/CB Tlg No new process data have been received by the TB or the CB within the telegram failure time.	r949 = 1: TB/CB r949 = 2: 2. CB <ul style="list-style-type: none"> • Check the connections of the CB/TB. • Check P722 "CB/TB TLG OFF". • Replace CB or TB.
F087	SIMOLINK initialization fault	<ul style="list-style-type: none"> • Replace CU • Replace SLB
F090	Mld Param. An error occurred when attempting to change a parameter from the standstill measurement or the rotating measurement (Mot ID).	Power down and power up again. If it re-occurs, replace the CU.
F091	Mld Time The rotating measurement takes longer than programmed in a measured status. Possible causes: <ul style="list-style-type: none"> • Load torque too high • Load torque not uniform • Ramp-function generator disabled 	Eliminate the cause and re-start the measurement (power up the converter again). If it re-occurs, replace the CU.

Fault number	Fault	Counter-measure
<p>F095</p>	<p>Mld n(set) Due to entries for</p> <ul style="list-style-type: none"> • Permissible phase sequence • Maximum frequency, • Minimum speed, • Changeover frequency between V and I model, • Start of field-weakening frequency, • Frequency suppression bandwidth <p>It was not possible to determine a permissible frequency range for the rotating measurement.</p>	<p>There must be a 10% frequency range which lies above 1.1 times the changeover frequency and below 0.9 times the start of field-weakening frequency. Possible counter-measures;</p> <ul style="list-style-type: none"> • Permit both phase sequences • Increase maximum frequency • Reduce minimum speed, • Reduce changeover frequency between the V and I model. • Reduce or remove the frequency suppression bandwidth.
<p>F096</p>	<p>Mld abort The rotating measurement was aborted due to inadmissible external intervention.</p>	<p>The fault value in r949 defines the type of intervention:</p> <ul style="list-style-type: none"> 4 Setpoint inhibit 5 Changeover, setpoint channel 8 Unexpected change in the converter status 12 Motor data set changeover (for function selection "Compl. Mot ID") 13 Changeover to slave drive 14 Motor data set changeover to data set with v/f_charac 15 Controller inhibit is set 16 Ramp-function generator is disabled 17 Selection "Tacho test" for F controller 18 Ramp-function generator stopped <p>innate cause</p>
<p>F097</p>	<p>Mld measured value The measured values for the nominal ramp-up time when optimizing the controller deviate too greatly. Cause: very unsteady load torque</p>	<p>If necessary, increase the torque limit values to 100 percent</p>

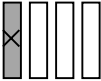
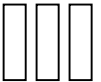
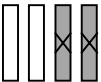
Fault number	Fault	Counter-measure
<p>F098</p>	<p>Mld Tachof</p> <p>The rotating measurement has detected a fault in the speed actual value signal. The fault value defines the type of fault.</p> <p>The fault message may have been erroneously generated if the drive speed is externally forced (e.g. completely locked drive generates the "no signal" message)</p>	<p>The fault value in r949 defines the type of intervention</p> <p>4 No speed signal present 5 Sign of the signal is incorrect 6 A track signal is missing 7 Incorrect gain 8 Incorrect pulse number</p> <p>Checking the measurement cables. Checking the parameters</p> <ul style="list-style-type: none"> • P130 Src Speed ActV • P151 Encoder Pulse #
<p>F100</p>	<p>GRND Init</p> <p>During the ground fault test, a current not equal to zero has been measured, or an UCE or overcurrent monitoring has responded, although no valve has yet been triggered.</p>	<p>The cause of the fault can be read out from r376 "GrdFltTestResult".</p> <p>Check the converter output for short-circuit or ground fault (-X2:U2, V2, W2 – including motor).</p> <p>Check that the CU is inserted correctly.</p> <p>Sizes 1 and 2:</p> <ul style="list-style-type: none"> • Check the transistor modules on the PEU board -A23 for short-circuit. <p>Size 3 and 4:</p> <ul style="list-style-type: none"> • Check the transistor modules -A100, -A200, -A300 for short-circuit
<p>F101</p>	<p>GRND UCE</p> <p>During the ground fault test, the UCE monitoring has responded in a phase in which no valve has been triggered.</p>	<p>Check valves in the power section for short-circuit, and on converters with fiber-optic gating, check the gating unit wiring and the UCE checkbacks for correct assignment.</p> <p>r376 can be interrogated to indicate which UCE monitoring has responded.</p>
<p>F102</p>	<p>GRND Phase</p> <p>During the ground fault test, a current flows in a phase in which no valve has been triggered or the UCE monitoring has responded in the phase in which the valve has been triggered.</p>	<p>The fault value can be read out from r949. The digit of the xth position indicates the valve where the fault occurred at power-up</p> <p></p> <p>The figure of the xth digit indicates the phase in which I ### 0 and thus a valve must be defective (always conductive).</p> <p></p> <p>Examine phase for defective valves (always conductive).</p>

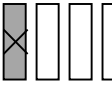
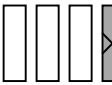
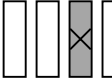
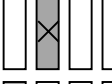
Fault number	Fault	Counter-measure
<p>F103</p>	<p>Ground fault</p> <p>There is a ground fault or a fault in the power section.</p> <p>During the ground fault test, a current flows from the phase in which a valve has been triggered, the overcurrent comparator has responded, or a UCE monitoring has responded in a phase in which a valve has been triggered.</p>	<p>Read out fault value from r949. The digit of the xth position indicates the valve where the fault occurred at power-up.</p>  <p>x = 1 = V+ x = 2 = V- x = 3 =U+ x = 4 = U- x = 5 = W+ x = 6 =W-</p> <p>Check the motor including the feeder cable for short-circuit. If no ground fault is present, check the power section for defective valves (always conductive).</p> <p>The digit of the xth position indicates the phase in which I ### 0 and therefore a valve must be defective (always conductive).</p>  <p>1 = Current in phase 1 (U) 2 = UCE in phase 2 (V) 1) 3 = Current in phase 3 (W) 4 = Only overcurrent occurred</p> <p>The speed of the motor shaft during the ground fault test should be less than 10 % of the nominal speed!</p> <p>1) A ground fault or a defective valve (always conductive) is present in phase V or the switch for 'SAFE OFF' (X9/5-6) is open (only for units with Order No. ...-11, ...-21,...-31).</p>
<p>F107</p>	<p>MId I = 0</p> <p>A fault has occurred during the test pulse measurement.</p>	<p>Read out fault value from r949. The figures of the grey shaded areas indicate which fault has occurred.</p> <p>xx = 01: Both current actual values remain 0 xx = 02: Motor-converter cable phase U interrupted xx = 03: Motor-converter phase V interrupted xx = 04: Motor-converter phase W interrupted xx = 05: Current actual value I1 remains 0 xx = 06: Current actual value I3 remains 0</p>  <p>xx = 07: Valve U+ does not trigger xx = 08: Valve U- does not trigger xx = 09: Valve V+ does not trigger xx = 10: Valve V- does not trigger xx = 11: Valve W+ does not trigger xx = 12: Valve W- does not trigger xx = 13: Sign I1 incorrect xx = 14: Sign I3 incorrect xx = 15: Sign I1 and I3 incorrect xx = 16: I1 confused with I3 xx = 17: I1 confused with I3 and both currents have an incorrect sign</p> <p>The digit of the grey shaded area indicates where the fault has occurred.</p>

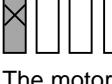
Fault number	Fault	Counter-measure
		 <p>x = 0 = Single converter x = 1 = Inverter 1 x = 2 = Inverter 2 x = 3 = Inverters 1 and 2</p> <p>Check that all 3 motor feeder cables and the motor windings do not have any interruption. Check the connection between the current converter and the electronics and check the current converter itself. Check the correct input of the rating plate data for the motor data set valid during the measurement.</p>
F108	Mld Unsym During the DC measurement, the measurement results for the individual phases differ significantly. The fault value indicates which quantity(ies) is (are) concerned and in which phase the greatest deviation occurred.	Read out fault value from r949. The digit of the xth position indicates;  Transverse voltage too high x = 1 = phase R; x = 2=phase S; x = 3 = phase T  Dev. stator resistance (1, 2, 3 as above)  Dev. rotor resistance (1, 2, 3 as above)  Dev. dead-time compensation (1, 2, 3 as above)  Deviation valve voltage (1, 2, 3 as above) The motor, power section or actual-value sensing are significantly non-symmetrical.
F109	Mld R(L) The rotor resistance determined during DC measurement deviates too significantly from the value which was calculated by the automatic parameterization from the rated slip.	<ul style="list-style-type: none"> • Incorrect input of rated speed or rated frequency • Pole pair number incorrect
F110	Mld di/dt During test pulse measurement, the current has increased significantly faster than was expected. Thus for the 1 st test pulse, an overcurrent condition occurred within the first half of the minimum switch-on time.	<ul style="list-style-type: none"> • There may be a short-circuit between two converter outputs. • The motor rating plate data have not been correctly parameterized. • The motor leakage is too low.
F111	Fault e_Func A fault has occurred while calculating the equalization function.	
F112	Unsym I_sigma The individual leakage test results deviate too significantly.	

Fault number	Fault	Counter-measure
F114	Mid OFF The converter has automatically aborted the automatic measurement as the time limit was exceeded up to converter power-up, or due to an OFF command during the measurement; the selection in P115 Function Select is reset.	For P115 Function Select = 2 restart "Motor data identification at standstill". The ON command must be provided within 20 s after the alarm message A078 = standstill measurement appears. Withdraw the OFF command, and restart the measurement.
F115	KF internal	Power-down the converter and electronics and power-up again.
F148	Fault 1 Function blocks	Check cause of fault, see function diagram 710
F149	Fault 2 Function blocks	Check cause of fault, see function diagram 710
F150	Fault 3 Function blocks	Check cause of fault, see function diagram 710
F151	Fault 4 Function blocks	Check cause of fult, see function diagram 710
F243	Link int. Faults in internal linking. One of the two linked partners does not reply.	Replace CU (-A10).
F244	ParaLink int. Fault in the internal parameter linking	Release comparison of MWH software and CU software regarding the transfer parameters. Replace CU (-A10).
F255	Fault in the EEPROM	Switch off the unit and power it up again. If it occurs again, replace the CU.

Table 11-1 Fault numbers, causes and their counter-measures

Alarms

The alarm message is periodically displayed on the PMU by A = alarm/ alarm message and a 3-digit number. An alarm cannot be acknowledged. It is automatically deleted once the cause has been eliminated. Several alarms can be present. The alarms are then displayed one after the other.

When the converter is operated with the OP1S operator control panel, the alarm is indicated in the lowest operating display line. The red LED additionally flashes (refer to the OP1S operating instructions).

Alarm number	Param. No.	Cause	Counter-measure
	Bit No.		
A001	r953	Calculating time The CUVC board calculating time utilization is too high	<ul style="list-style-type: none"> Observe r829 CalcTimeHdroom Increase P357 Sampling Time or Reduce P340 Pulse Frequency.
	0		
A002		SIMOLINK start alarm	Check <ul style="list-style-type: none"> the fiber-optic cable ring whether there is an SLB without voltage in the ring whether there is a faulty SLB in the ring P741 (SLB TIg OFF)
A014	r953	Simulation active alarm The DC link voltage is not equal to 0 when the simulation mode is selected. (P372 = 1)	<ul style="list-style-type: none"> Set P372 to 0 Reduce DC link voltage (disconnect the converter from the supply)
	13		
A015	r953	External alarm 1 Parameterizable external alarm input 1 has been activated	Check <ul style="list-style-type: none"> Whether the cable to the corresponding digital input is interrupted. Parameter P588 Src No Ext Warn1
	14		
A016	r953	External alarm 2 Parameterizable external alarm input 2 has been activated	Check <ul style="list-style-type: none"> Whether the cable to the corresponding digital input is interrupted. Parameter P589 Src No Ext Warn2
	15		
A017	r954	SAFE OFF alarm active The switch for blocking the inverter pulses (X9 terminal 5-6) has been opened (only for units with Order No. ...-11, ...-21,...-31).	Close switch X9 5-6 and thus release the inverter pulses.
	0		
A020	r954	Overcurrent An overcurrent condition has occurred.	Check the driven load for an overload condition. <ul style="list-style-type: none"> Are the motor and the converter matched? Have the dynamic performance requirements been exceeded?
	3		

Alarm number	Param. No.	Cause	Counter-measure
	Bit No.		
A021	r954	Overvoltage An overvoltage condition has occurred.	Check the supply voltage. The converter regenerates without regeneration possibility.
	4		
A022	r954	Inverter temperature The threshold for initiating an alarm has been fallen short of.	<ul style="list-style-type: none"> Observe r833 Drive Tmp. Measure intake air or ambient temperature. Observe reduction curves at ### >40 °C . Check: <ul style="list-style-type: none"> Whether the fan -E1 is connected and is rotating in the correct direction. The air intake and discharge openings for blockage. The temperature sensor at -X30.
	5		
A023	r954	Motor temperature The parameterizable threshold for initiating an alarm has been exceeded.	Check the motor (load, ventilation, etc.). The current temperature can be read in r009 Motor Tmp. Check the KTY84 input at connector X103:29,30 for short-circuit.
	6		
A024	r954	Motor movement The motor has moved during motor data identification in first start-up.	Lock the motor
	7		
A025	r954	I2t Inv. If the instantaneous load condition is maintained, then the inverter will be thermally overloaded.	Motor load cycle exceeded! Check the parameters: P382 Motor Cooling P383 Mot Tmp T1 P384 Mot Load Limits
	8		
A029	r954	I2t motor The parameterized limit value for the I2t monitoring of the motor has been exceeded.	Motor load cycle is exceeded! Check the parameters: P382 Motor Cooling P383 Mot Tmp T1 P384 Mot Load Limits
	12		
A033	r955	Overspeed Bit 3 in r553 status word 2 of the setpoint channel. The speed actual value has exceeded the value of maximum speed plus the set hysteresis.	P804 Overspeed Hyst plus P452 n/f(max, FWD Spd) or P453 n/f(max, REV Spd) has been exceeded. Increase the parameter for the maximum frequencies or reduce the regenerative load.
	0		
A034	r955	Setpoint/actual value deviation Bit 8 in r552 status word 1 of setpoint channel. The difference between frequency setpoint/actual value is greater than the parameterizable value and the control monitoring time has elapsed.	Check: <ul style="list-style-type: none"> Whether an excessive torque requirement is present. Whether the motor has been dimensioned too small. Increase values P792 Perm Deviation Frq/ set/actual DevSpeed and P794 Deviation Time
	1		

Alarm number	Param. No.	Cause	Counter-measure
	Bit No.		
A035	r955	Wire break The clockwise and/or the counter-clockwise rotating field is not enabled, or a wire breakage is present in the terminal wiring (both control word bits are zero)	Check whether cable(s) to the corresponding digital input(s), P572 Src REV Speed/ P571 Src FWD Speed is (are) interrupted or released.
	2		
A036		Brake checkback "Brake still closed"	Check the brake checkback (see FD 470)
A037		Brake checkback "Brake still open"	Check brake checkback (see FP 470)
A041	r955	Vdmax controller inhibit The line voltage is too high or the drive line voltage (P071) is incorrectly parameterized. The Vdmax controller is disabled despite parameter access (P515), as otherwise the motor would accelerate immediately in operation to the maximum frequency.	Check: <ul style="list-style-type: none"> • Line voltage • P071 Line Volts
	8		
A042	r955	Motor stall/lock Motor is stalled or locked. The alarm cannot be influenced by P805 " PullOut/BlckTime", but by P794 "Deviation Time".	Check: <ul style="list-style-type: none"> • Whether the drive is locked. • Whether the encoder cable is interrupted during speed control and whether the shield is connected. • Whether the drive has stalled. • For synchronous motors (P095=12): excitation current injection
	9		
A043	r955	n-act jump The permissible change value of the speed encoder signal (P215) has been exceeded. Additionally for synchronous motors (P095=12): The motor rotates with more than 2 % of the rated speed at the time of inverter release. The inverter status "Ready for operation" is not exited.	Check the tachometer cables for interruptions. Check the earthing of the tachometer shield. <ul style="list-style-type: none"> • The shield must be connected both on the motor and on the converter side. • The encoder cable must not be interrupted. • The encoder cable must not be laid with the power cables. • Only the recommended encoders should be used. • If there is a signal fault, use the DTI board if necessary. • If necessary, change P215 • Additionally for synchronous motors (P095=12): Do not grant inverter release until the motor is at standstill.
	10		

Alarm number	Param. No.	Cause	Counter-measure
	Bit No.		
A044	r955	I too low Only for synchronous motors (P095=12) in operation: The difference smoothed with P159 between excitation current setpoint and actual value (r160 - r156) deviates from zero by more than 25 % of the rated magnetizing current.	Only for synchronous motors P095 = 12 Check: <ul style="list-style-type: none"> • Whether the current limitation of the excitation current control is too small. • Whether the dynamic performance of the excitation current injection is too low. • Whether the excitation current injection function is operating, • Whether the wiring of excitation current actual-value P155 is correct, • Whether the wiring of excitation current setpoint r160 is correct, • Whether there is a wire breakage between MASTERDRIVES and the excitation device. • Whether the voltage limitation is too low for dynamic excitation current control. • Whether the analog output for r160 takes place without isolating amplifiers (despite cable length > 4m).
	11		
A045	r955	DC braking activated The DC braking function has been activated and the motor frequency is still above the frequency at which DC braking begins (P398).	<ul style="list-style-type: none"> • Increase frequency at which DC braking begins.
	12		
A049	r956	No slave At ser. I/O (SCB1 with SC11/2) no slave is connected or fiber-optic cable is interrupted or slaves are without voltage.	P690 SCI Analn Conf <ul style="list-style-type: none"> • Check slave. • Check cable.
	0		
A050	r956	Slave incorrect At ser. I/O the slaves required according to a parameterized configuration are not present (slave number or slave type).	Check P690 SCI Analn Conf
	1		
A051	r956	Peer Bdrate In a peer-to-peer connection, a baud rate has been selected which is too high or too different.	Adjust the baud rate in conjunction with the SCB boards P701 SCom/SCB Baud Rate
	2		
A052	r956	Peer PcD L In a peer-to-peer connection, a PcD length has been set which is too high (>5).	Reduce number of words P703 SCom PcD #.
	3		
A053	r956	Peer Lng f. In a peer-to-peer connection, the PcD length of transmitter and receiver do not match.	Adjust the word length for transmitter and receiver P703 SCom/SCB PcD #
	4		

Alarm number	Param. No.	Cause	Counter-measure
	Bit No.		
A057	r956	TB Param Occurs when a TB is logged on and present, but parameter tasks from the PMU, SCom1 or SCom2 are not answered by the TB within 6 seconds.	Replace TB configuration (software).
	8		
A061		Alarm 1 function blocks	Check cause of alarm (see FP 710)
A062		Alarm 2 function blocks	Check cause of alarm (see FP 710)
A063		Alarm 3 function blocks	Check cause of alarm (see FP 710)
A064		Alarm 4 function blocks	Check cause of alarm (see FP 710)
A065	r957	Auto restart active The auto restart option (P373) restarts the drive. A possibly parameterized power-up delay time (P374) expires if flying restart is not selected. During pre-charging of the DC link, there is no time monitoring i.e. with an external electronics power supply, it is also switched-in again.	Caution! Personnel could be in danger when the drive automatically restarts. Check whether the auto restart function is really required!
	0		
A066	r957	fsyn > fmax The measured target frequency of the external converter (or supply) is greater than the parameterized maximum frequency of the synchronizing converter.	Check: <ul style="list-style-type: none"> • P452 n/f(max, FWD Spd)/ P453 n/f(max,REV Spd) are correct and • Correct motor data set P578 Src MotDSet Bit0 are selected.
	1		
A067	r957	fsyn < fmin The measured target frequency of the external converter (or supply) is less than the minimum frequency required for synchronizing.	Check: <ul style="list-style-type: none"> • r533 Sync Target Freq • Synchronising cable
	2		
A068	r957	fsyn<>fsoll The setpoint frequency of the synchronizing converter deviates too significantly from the measured target frequency of the external converter (or supply). The permissible deviation can be set in P529.	Adjust total setpoint (main and additional setpoints) to the target frequency displayed in visualization parameter r533.
	3		
A069	r957	RGen active Synchronizing is not started as long as the ramp-function generator in the synchronizing converter setpoint channel is active. This alarm is only output if synchronizing is selected.	Wait until acceleration has been completed. Check whether: <ul style="list-style-type: none"> • P462 Accel Time • P463 Accel Time Unit has been correctly set.
	4		
A070	r957	Sync. Error This alarm is output if the phase difference goes outside the	The alarm can only be deleted after synchronization has been exited.
	5		

Alarm number	Param. No.	Cause	Counter-measure
	Bit No.		
		synchronizing window (P 391) after successful synchronization.	
A071	r957	TSY missing An attempt was made to start synchronization with either the synchronizing board not inserted or not parameterized.	Insert the TSY board in the subrack.
	6		
A076	r957	t-comp lim The determined compensation time was limited to the value range of 0.5µs - 1.5µs.	The converter output and the motor output are too different. Check motor data entries P095 to P109.
	11		
A077	r957	r-g limit The measured resistance was limited to the maximum value of 49 %.	Converter output and motor output are too different. Check motor data entries P095 to P109.
	12		
A078	r957	Standst. Meas The standstill measurement is executed when the converter is powered-up. With this measurement, the motor can align itself in any direction of rotation.	If the standstill measurement can be executed without any danger: <ul style="list-style-type: none"> • Power up the converter
	13		
A079	r957	Mld Inv Stop The rotating measurement has been aborted or cannot commence because an inverter stop command is present.	P561 Src InvRelease – Release the inverter or re-start the measurement by powering-up the converter.
	14		
A080	r957	MotId:Dr.M. When the converter is powered-up, the rotating measurement automatically accelerates the drive. The drive can then only be externally controlled in a very restricted fashion.	If the rotating measurement can be executed without any danger: <ul style="list-style-type: none"> • Power-up the converter
	15		
A081.. A096	r958	CB alarm See user manual for CB board	
	1...15		
A097.. A112	r959	TB alarm 1 See user manual for TB board	
	1...15		
A113.. A128	r960	TB alarm 2 See user manual for TB board	
	1...15		

Table 11-2 Alarm numbers, causes and their counter-measures

Fatal errors (FF) Fatal errors are serious hardware or software errors which no longer permit normal operation of the unit. They only appear on the PMU in the form "FF<No>". The software is re-booted by actuating any key on the PMU.

FFxx	Error message	Power-down the converter and power-up again. Call the service personnel if a fatal error message is displayed again
FF01	Time slot overflow A non-removable time sector overflow was identified in the higher priority time sectors.	<ul style="list-style-type: none"> • Increase sampling time (P357) or reduce pulse frequency (P340) • Replace CU
FF03	Access error, optional board Fatal errors occurred when accessing external optional boards (CB, TB, SCB, TSY ..)	<ul style="list-style-type: none"> • Replace CU • Replace LBA • Replace optional board
FF06	Stack overflow Overflow of the stack.	<ul style="list-style-type: none"> • Increase sampling time (P357) or reduce pulse frequency (P340) • Replace CU
FFxx	Other fatal errors	<ul style="list-style-type: none"> • Replace CU
E	Fatal hardware errors	<ul style="list-style-type: none"> • Replace CU
EEEE	Fatal firmware errors	<ul style="list-style-type: none"> • Replace CU • Re-load firmware

Table 11-3 Fatal errors

12 Guidelines to changeover from CB1 to CBP

12.1 Reasons for the changeover

Essentially, there are two reasons for the changeover of PROFIBUS boards from CB1 to CBP:

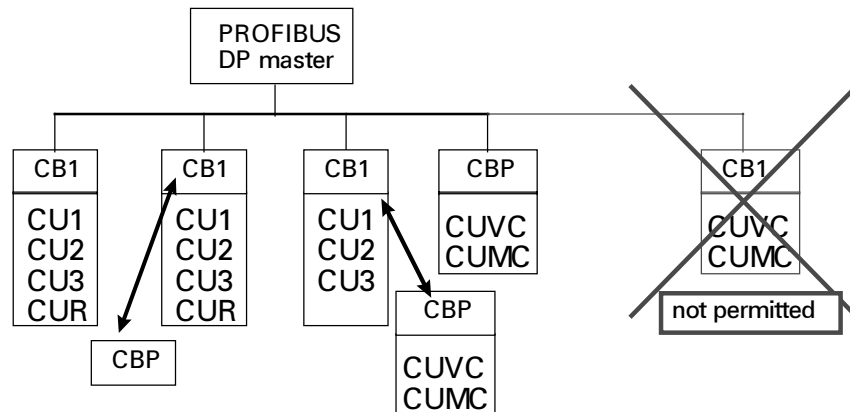

- ◆ In the scope of the changeover from MASTERDRIVES with a CU1-, CU2- or CU3 control module to MASTERDRIVES with a CUV- or CUMC control board, a complete drive converter with CUx- and CB1 module is replaced by a new drive converter with CUV- or CUMC and CBP module.
- ◆ Only the PROFIBUS module CB1 is replaced by a new PROFIBUS module CBP e.g. because you wish to use the higher baud rate or the expanded functions of the CBP, also together with a CU1-, CU2-, CU3- or also a CUR control module.

In both cases, you will have to modify the bus software in the PROFIBUS-DP master; i.e. the two CB1 and CBP modules are not compatible on the master side.

The necessary steps, i.e. to change an existing DP master software to an equivalent software with CBP modules will now be described in the following.

Essentially, a differentiation is made between two user groups:

- ◆ SIMATIC S5 user
- ◆ SIMATIC S7 user

The guidelines should put you in a position to:

- ◆ Estimate the time and costs for such a changeover
- ◆ Make all of the necessary preparations, e.g. regarding GSD/type descriptive files
- ◆ Make the necessary steps using an example

12.2 Comparison, CB1 ⇔ CBP

Overview table

The following table is intended to give you some guidelines as to common features between CB1 and CBP, but also to clearly refer to the differences of the two master drives communications modules for PROFIBUS-DP.

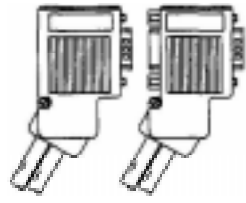
	Old module CB 1	New module CBP
Order No.:	6SE7090-0XX84-0AK0	6SE7090-0XX84-0FF0
Instruction Manual:	6SE7087-8CX84-0AK0	Sec.8.2 of the Compendium
PNO identification No.	8022	8045
Required GSD/type file	SIEM8022.GSD SI8022AX.200	SIEM8045.GSD SI8045AX.200
Baud rates	9.6 kbaud – 1.5 Mbaud	9.6 kbaud - 12 Mbaud
Bus connection	6 pin terminal strip Phoenix connector is included in the scope of supply of CB1	9-pin sub D socket 9-pin sub D plug connector  Should be separately ordered, acc. to Catalog DA 65.10 e.g. 6ES7 972-0BA10-0XA0 6ES7 972-0BA20-0XA0
Support standard DP	yes	yes
Supports non-cyclic data transfer	no	yes
Possible to couple SIMOVIS V 5.0 via Profibus	no	yes
Function block packages which can be used	DVA_S5 all versions and DVA_S7 all versions	DVA_S5 from V 4.0 and DVA_S7 from V 2.0
Can be used with FC (CU1)	yes, can be directly inserted in the electronics box	yes, can be inserted in the electronics box with support board ADB 6SE7090-0xx84-0KA0
Can be used with VC (CU2)	yes, can be directly inserted in the electronics box	yes, can be inserted in the electronics box with support board ADB 6SE7090-0xx84-0KA0

	Old module CB 1	New module CBP
Can be used with SC (CU3)	yes, can be directly inserted in the electronics box	yes, can be inserted in the electronics box with support board ADB 6SE7090-0xx84-0KA0
Can be used with CUMC	no	yes Can be directly inserted on the CU or inserted in the electronics box with support board 6SE7090-0xx84-0KA0
Can be used with CUVC	no	yes Can be directly inserted on the CU or inserted in the electronics box with support board 6SE7090-0xx84-0KA0
Can be used with Compact Plus	no	yes can be directly inserted on the Compact Plus baseboard

12.3 Parameter numbers of the individual CUs regarding PROFIBUS

Depending on which CD control module, the CBP is used with, then a differentiation is made between the parameter numbers, which are used to enter the settings for PROFIBUS.

Parameter name	Parameter number for MASTERDRIVES with CU1, CU2, CU3 and CUR	Parameter number for MASTERDRIVES with CUMC and CUVC
Profibus address	P 918	P 918
CB parameter 1	P 696	P 711
CB parameter 2	P 697	P 712
CB parameter 3	P 698	P 713
CB parameter 4	P 699	P 714
CB parameter 5	P 700	P 715
CB parameter 6	P 701	P 716
CB parameter 7	P 702	P 717
CB parameter 8	P 703	P 718
CB parameter 9	P 704	P 719
CB parameter 10	P 705	P 720
CB parameter 11	-----	P 721
CB-/TB	P 695	P 722
CB-/TB actual values	P 694	P 734

12.4 Information on the GSD- and type files for the new COM-BOARD CBP

Different versions of the type description/GSD file are required for the different versions of SIMATIC S5 and S7.

General information All type/GSD files for the MasterDrives PROFIBUS board CBP have the PNO identification 8045 in the name.

You can use the following list to define which type file / GSD file is used for which Siemens PROFIBUS master.

Name of the type/GSD files:	SI8045AX.200	For SIMATIC S5 with COM ET200 WIN and S7 from Version V 3.x
	SIEM8045.GSD	For SIMATIC S5 with IM308C and COM PROFIBUS from V3.0
	SI80451X.200 : SI80455X.200	For SIMATIC S7 with STEP7 Version V2.x

These files are provided on a floppy disk, which is supplied together with the CBP module.

A differentiation should be made between the following applications:

SIMATIC S5

◆ SIMATIC S5 with IM308C and COM-PROFIBUS from Version V 3.0:

The GSD file as well as the type description file can be used for this application.

- **Using the GSD file:**

Copy the GSD file SIEM8045.GSD into the COM Profibus directory GSD.

Select the menu item update GSD files, in the "file" menu, and execute this command.

Then, check in the menu "Documentation" ⇒ menu item "type / GSD files" whether you can see the new entry of "Master Drives CBP".

If this is the case, CBP can be configured as usual, analog to CB1. If not, repeat the update.

- **Using the type file:**

Copy the type.file SI8045AX.200 into the COM-Profibus directory "TYPDAT5x".

Then, in the "file" menu, select the update GSD file menu item, and execute this command.

Then, check in the menu "Documentation" ⇒ menu item "type / GSD files", whether you can see the new entry of "Master Drives CBP".

If this is the case, CBP can be configured as usual, analog to CB1. If not, repeat the update.

◆ SIMATIC S5 with IM308C and COM Windows up to Version V 2.x:

Only the type description file can be used for this application.

- **Using the type file:**

Copy the type.file SI8045AX.200 into the COM-Profibus directory "TYPDAT5x".

Then, in the "file" menu, select the menu item update type files, and execute this command.

Then, check in the menu "Documentation" ⇒ menu item "type / GSD files", whether you can see the new entry of "Master Drives CBP".

If this is the case, CBP can be configured as usual, analog to CB1. If not, repeat the update.

SIMATIC S7◆ **SIMATIC S7 with STEP7 V2.1 and integrated DP interfaces:**

Only special type description files can be used for this application.

• **Using the type files:**

Copy the type files SI80451X.200 to SI80455X.200 into the STEP7 directory

“STEP7 ⇒ S7DATA ⇒ type file”.

Then, in the "Extras" menu of the SIMATIC hardware configuration, select the "update DP type files" menu item, and execute this command.

Then, in the "Hardware Catalog" check whether you can find the new entries under the hardware catalog path "PROFIBUS DP ⇒ NORMSLAVE ⇒ DRIVES". They are displayed there under the "CBP-PPO1" to "CBP-PPO5" names.

If this is the case, the CBP can be configured as usual, analog to the CB1.

Directly select entries such as "CBP-PPO1", however, not the "subordinate" standard module

If the new entries are not displayed, repeat the update.

It may be necessary to exit STEP7 and then restart it again.

◆ **SIMATIC S7 with STEP7 V3.x , STEP7 V4.x and integrated DP interfaces:**

Only the type description file can be used for this application.

• **Using the type files:**

Copy the type.file SI8045AX.200 into the STEP7 directory

“STEP7 ⇒ S7DATA ⇒ GSD”.

Then, in the "Extras" menu of the SIMATIC hardware configuration, select the "update GSD type files" menu item, and execute this command.

Then, in the "Hardware Catalog" menu, check whether you can find the new entry under "PROFIBUS-DP ⇒ additional field devices ⇒ Simovert". They are displayed there under the "Master Drives CBP" names.

(If the new entries are not displayed, repeat the update. It may be necessary to exit STEP7 and then restart it again.)

12.5 Examples of the steps required

12.5.1 General information

- ◆ Replacing the modules

If the CBP cannot be directly mounted on the CUVC, e.g. as other options are already inserted there, the CBP must be inserted into the electronics box on an adapter board.

- ◆ Connecting the new CBP to the bus cable

For the CBP, the bus cable is connected via a 9-pin bus connector. The terminals in the bus connector also have the names "A" and "B" just like the terminals in the CB1 connector. Thus, the bus cable cores in the new connector should be connected again under the same names/designations as in the CB1 connector. It is not necessary to insert two cores into one terminal, as the two A terminals as well as the two B terminals are connected in the bus connector.

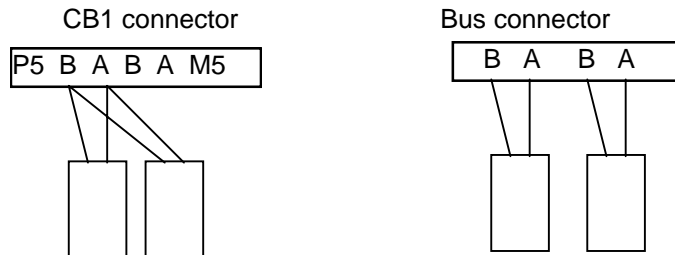

12.5.2 Configuring steps in the DP master "SIMATIC S5"

SIMATIC S5

For SIMATIC S5, the procedure will be explained using as an example, the COM PROFIBUS V3.0 configuring tool.

Preparations required:

- ◆ Ensure that you have the right software on your computer or that you have a floppy disk with the associated software ready.
- ◆ Ensure that the type file SI8045AX.200 required for the CBP, is in the Typdat5x directory of your COM PROFIBUS Installation. If this is not the case, then before starting your session, copy the SI8045AX.200 type file from the floppy disks included with the CBP, into the directory "Typdat5x" according to the information in Section 12.4 "Information on GSD and type files for the new COM board CBP".
→ From COM PROFIBUS, version V 3.2, the CBP is automatically included in the SIMOVERT product group

◆ Step 1: Deleting the stations with CB1

SIMATIC S5

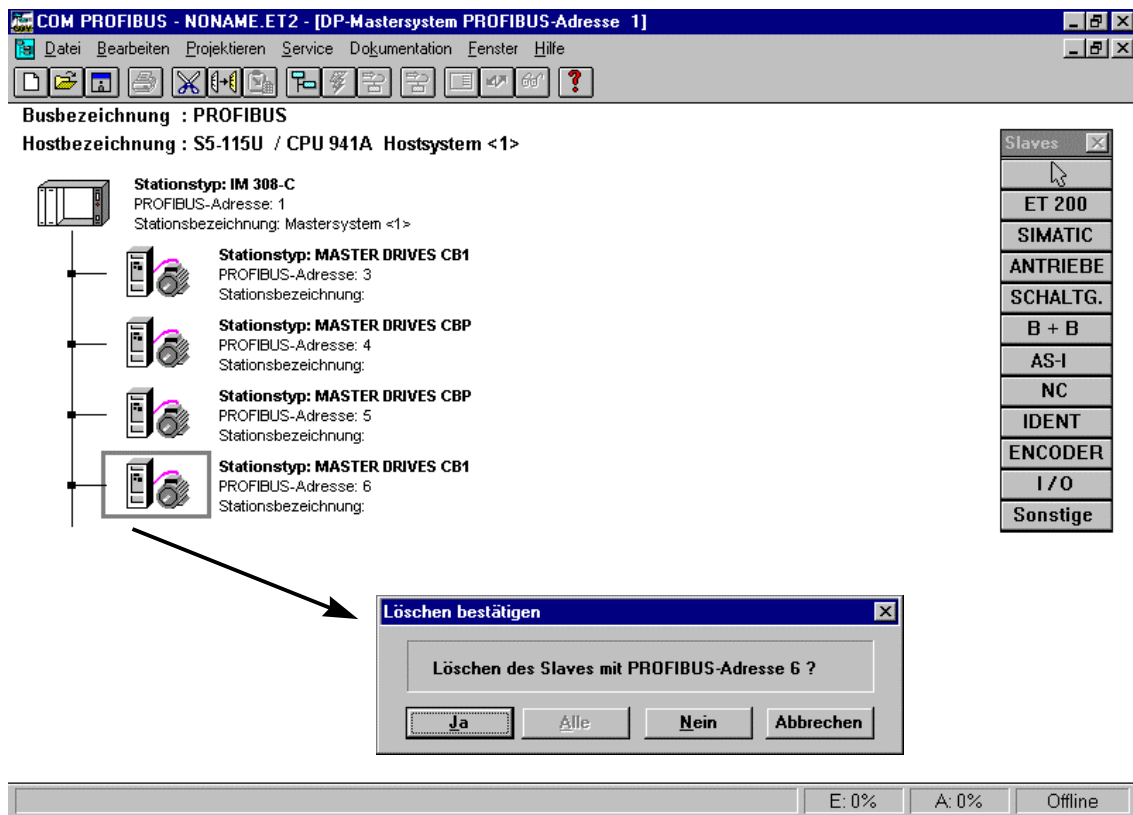

If a CB1 communications board is to be replaced by a CBP in a master PROFIBUS-DP software, then the following steps are required in the SIMATIC S5.

- ◆ Load the configuring file of the existing configuration (attachment) into the PG/PC
- ◆ Open the configuration file using the configuring tool (e.g. COM PROFIBUS)
- ◆ Open the station with the CB1 to be replaced, and document the configuring data used (e.g. response monitoring and peripheral addresses)
- ◆ **Completely delete** the station with the CB1 which is to be replaced
- ◆ Re-configure the station to be replaced, as CBP with the same bus address and the documented configuring data

◆ Step 2: Re-configuring the station with CBP

SIMATIC S5

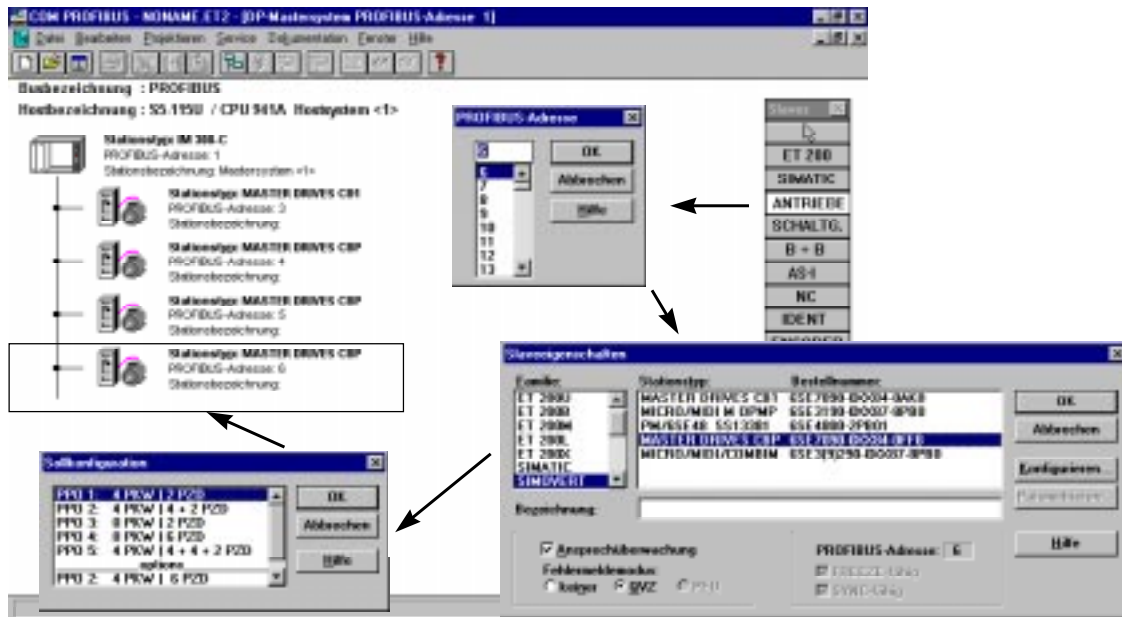

The station to be replaced is re-configured as CBP with the same bus address, according to the following schematic.

- ◆ Open the DRIVES slave family, and draw the bus connection
- ◆ Assign the bus address of the deleted CB1 to the new CBP
- ◆ Select CBP from the selection list, and transfer “configuring...” by pressing the button
- ◆ Select the configuration required corresponding to the documented information (i.e. the same which is used for CB1), and confirm with “OK”.
- ◆ Assign the CBP the same peripheral addresses, which were also used for CB1
- ◆ Save the modified software
- ◆ **Transfer the software to a memory card or EPROM**

12.5.3 Configuring steps in the DP master "SIMATIC S7"

SIMATIC S7

For SIMATIC S7 the procedure is to be explained, using as example, the STEP7 V3.0 hardware configuration.

Required preparations:

- ◆ Ensure that the right software is available on your computer or that you have a floppy disk with the appropriate software at hand.
- ◆ Ensure that you have the SI8045AX.200 type file, required for the CBP in the directory STEP7 → S7DATA → GSD of your STEP7 installation.

If this is not the case, before starting the session, copy the SI8045AX.200 type file from the floppy disk, included with the CBP, into the directory "STEP7 → S7DATA → GSD" according to the instructions in Section 12.4 "Information on GSD- and type files for the new COM board CBP".

→ From STEP7, Version V 4.1, the CBP is automatically included in the SIMOVERT product group.

◆ Step 1: Deleting the station with CB1

SIMATIC S7

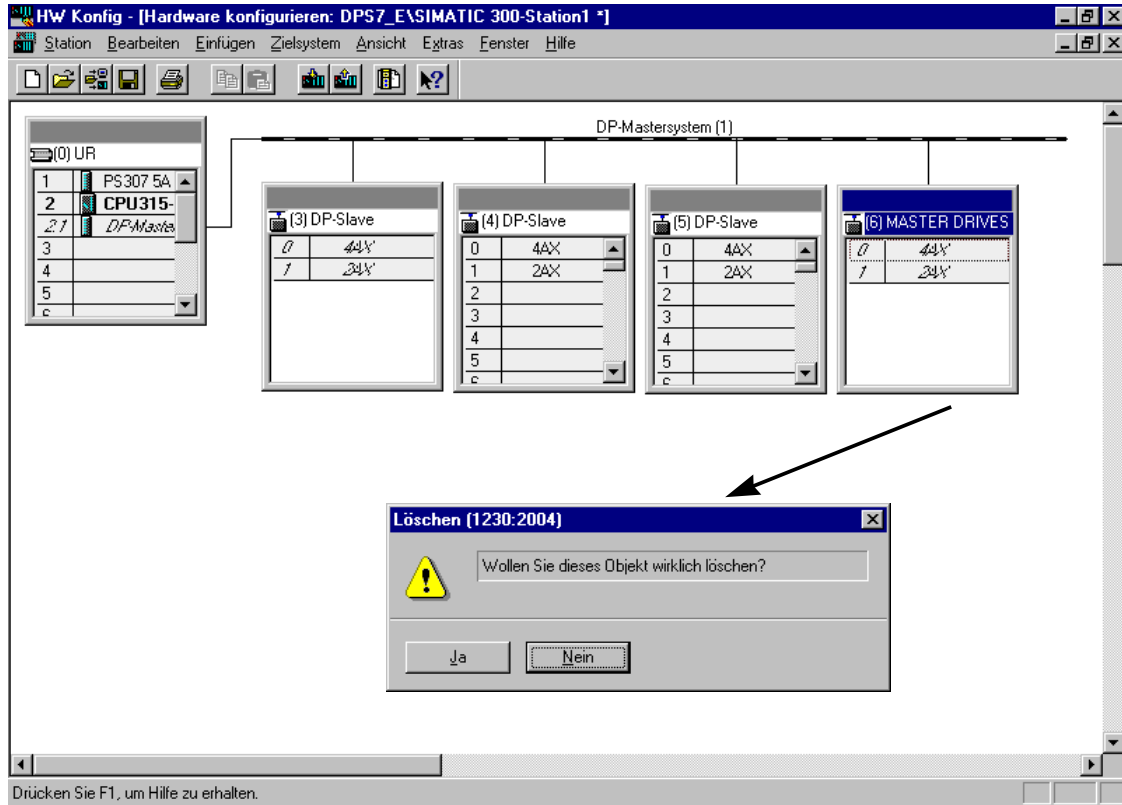

If a CB1 communications board is to be replaced by a CBP in an existing PROFIBUS-DP master software, then the following steps are required in the SIMATIC S7.

- ◆ Load the configuring file of the existing configuration (attachment) into the PG/PC
- ◆ Open the configuration file using the configuring tool (e.g. COM PROFIBUS)
- ◆ Open the station with the CB1 to be replaced, and document the configuring data used (e.g. response monitoring and peripheral addresses)
- ◆ **Completely delete** the station with the CB1 which is to be replaced

- ◆ Step 2: Re-configuring the station with CBP

SIMATIC S7

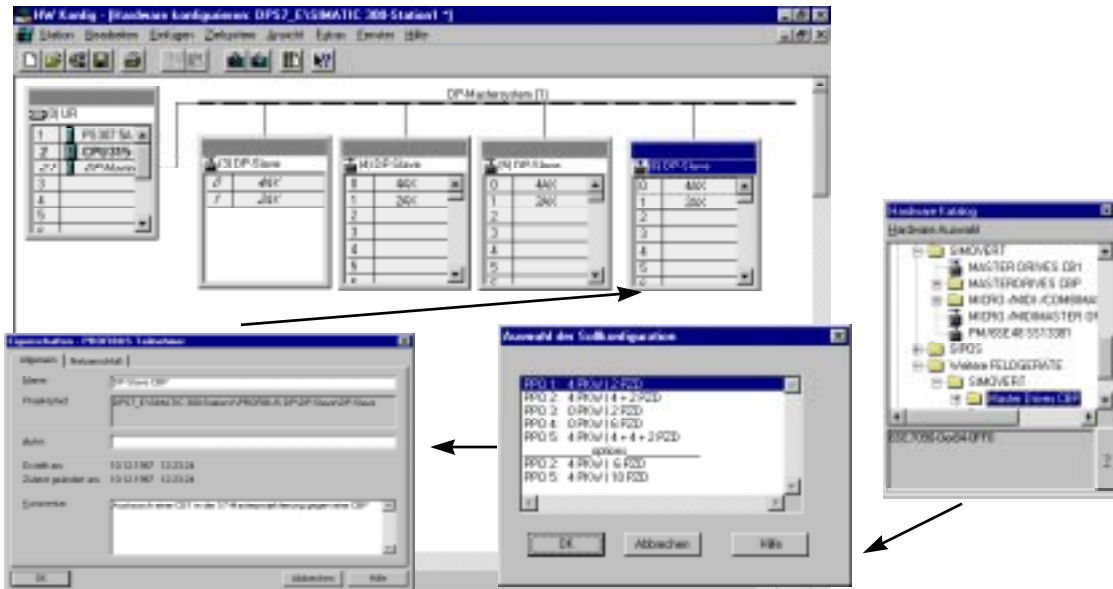

The station to be replaced is re-configured as CBP with the same bus address in the SIMATIC S7, according to the following schematic.

- ◆ Open the hardware catalog
- ◆ Select the CBP from the hardware catalog (either under SIMOVERT or under additional FIELD DEVICES --> SIMOVERT)
- ◆ Select the configuration you require corresponding to the data you documented (i.e. the same as was used for CB1) and confirm
- ◆ Assign the bus address of the deleted CB1 to the new CBP
- ◆ If it is not automatically realized, assign the CBP the same peripheral addresses, which were also used for CB1
- ◆ Save the modified software
- ◆ **Transfer the software into the CPU in the STOP condition** (i.e. the system is shutdown)